



CHRYSLER 300-300C

2008



CAN-SL-PL & TBCHR08

Made in Canada Rev. A - 14 / 01 / 2009

Web site: <http://www.ifar.ca>

ALARM AND REMOTE STARTER CAN BUS INTERFACE KIT

Fonctionnal if equipped

- | | | | |
|--|---|---|---|
| <input checked="" type="checkbox"/> Lock | <input checked="" type="checkbox"/> Tach | <input checked="" type="checkbox"/> Radio Off | <input type="checkbox"/> Heat Seats |
| <input checked="" type="checkbox"/> Unlock | <input type="checkbox"/> Start Enable | <input type="checkbox"/> Transponder Bypass | <input type="checkbox"/> Gas Door |
| <input checked="" type="checkbox"/> Arm | <input checked="" type="checkbox"/> Door Trigger | <input type="checkbox"/> PK3, Passlock | <input type="checkbox"/> Window Roll Down |
| <input checked="" type="checkbox"/> Disarm | <input checked="" type="checkbox"/> Trunk Trigger | <input type="checkbox"/> Sliding Door | <input type="checkbox"/> Hatch |
| <input checked="" type="checkbox"/> Trunk | <input type="checkbox"/> Hood Trigger | <input type="checkbox"/> Defrost | <input type="checkbox"/> Brake Signal |

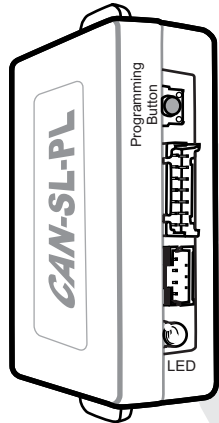

Front of the module

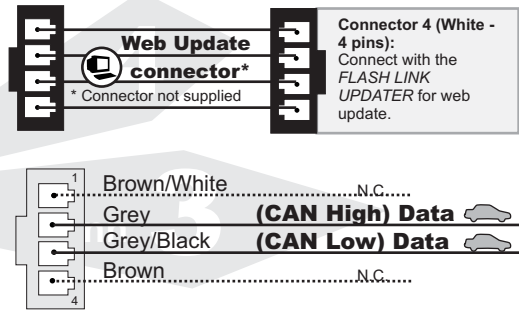
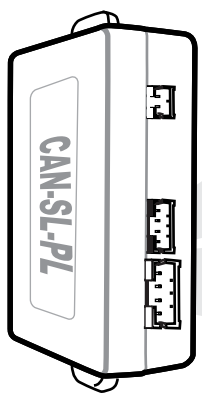
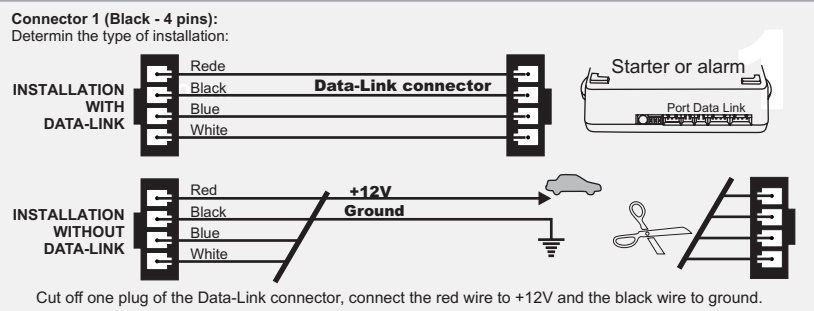
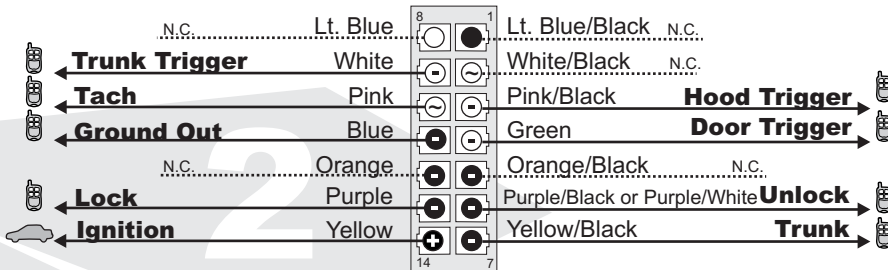

Twisted Pair Wires located at the ignition connector

Connect wire to Remote-Starter/Alarm Connect wire to vehicle ○ OUTPUT ● INPUT

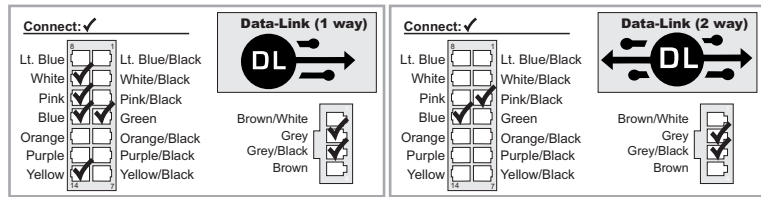

- 1.1.A** Make the connections of the CAN-SL-PL to the vehicle:
Connector 1 (Black):
 Determine the type of installation:
 INSTALLATION WITH DATA-LINK
 INSTALLATION WITHOUT DATA-LINK
- 1.1.B** **Connector 2 (White):**
 Make the connections
- 1.1.C** **Connector 3 (White, located at the back of the module):**
 Make the connections
- 2** Press the programming switch while inserting the main wires harness (CONN 1) into the CAN-SL-PL module. The LED will illuminate to indicate you are in programming mode, release the programming button.
- 3** Connect the other connectors (CONN. 2)

WARNING: Connector 2 can be easily plugged in backwards.
- 4** Connect the other connectors (CONN. 3)
- 5** Turn the key to the "ON" position.
- 6** Once the LED starts to flash rapidly turn the key to the OFF position.

The LED will turn off to indicate the module has been programmed.
- 7** The LED will flash until you press the OEM remote lock button.

The LED will turn off to indicate the module has been programmed.

The module is now ready for use.



Technical support:
 TEL: 514-255-HELP (4357)
 FAX: 514-255-1367
 Web: www.ifar.ca

Neither the manufacturer or distributor of this module is responsible of damages of any kind indirectly or directly caused by this module, except for the replacement of this module in case of manufacturing defects. This module must be install by qualified technician. This instruction guide may change without notice. Visit www.ifar.ca to get latest version.



CAN-SL-PL & TBCHR08

Made in Canada Rev. A - 14 / 01 / 2009
Web site: <http://www.ifar.ca>

ALARM AND REMOTE STARTER CAN BUS INTERFACE KIT

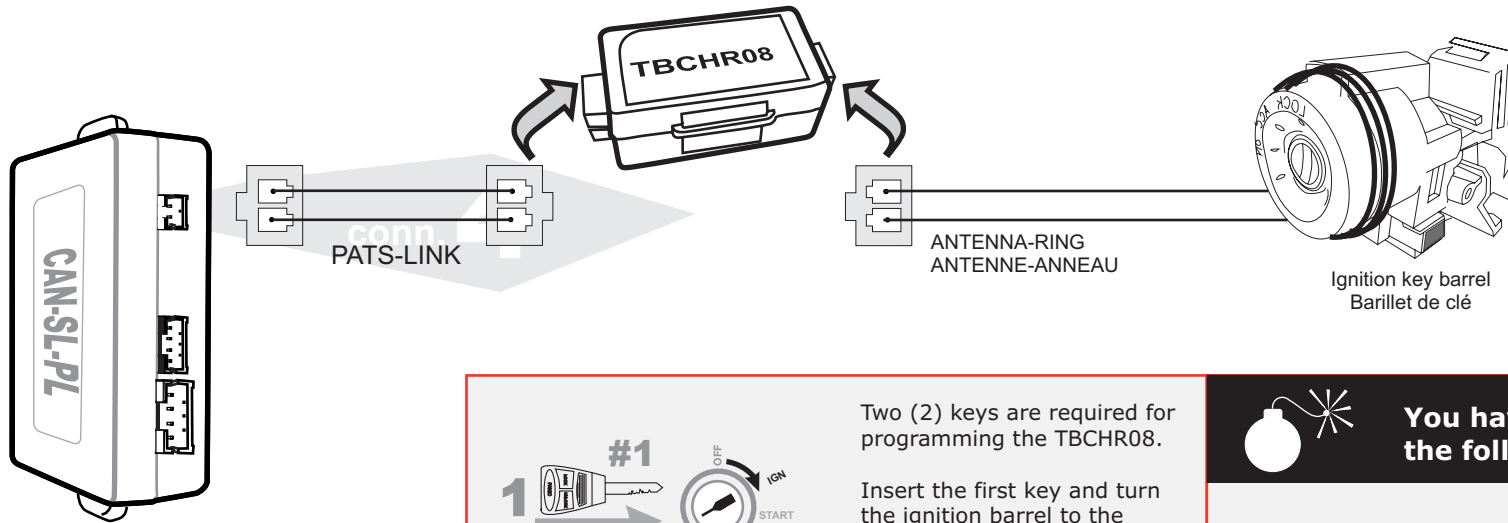

<p>1 #1</p>	<p>Two (2) keys are required for programming the TBCHR08.</p> <p>Insert the first key and turn the ignition barrel to the ON/RUN position for 10 seconds.</p>
<p>2 #1</p>	<p>Turn the key OFF and remove the first key.</p>
<p>3 #2</p>	<p>Insert the second key and turn the ignition barrel to the ON/RUN position for 10 seconds.</p>
<p>4 #2</p>	<p>Turn the key OFF and remove the second key.</p>



You have 60 seconds to complete the following steps

<p>5</p>	<ul style="list-style-type: none"> ➤ Remove the cover and the remote circuit board from inside the key-remote. ➤ Place the empty key against the TBCHR08 as shown on the figure below. ➤ Turn the ignition barrel to the ON/RUN position with both pieces together.
<p>6</p>	<ul style="list-style-type: none"> ➤ After 15 seconds a chime will sound and the security or check-engine light will stop flashing. ➤ Turn the ignition barrel off and remove the key. ➤ The TBCHR08 is now programmed
<p>7</p>	<p>If the programming fails please wait 5 minutes before trying this procedure again.</p> <p>Make 3 to 4 loops around the ignition barrel. (Secure the wire with tie-wrap.)</p>
<p>8</p>	<p>Connect the RBCHR08 module to the CAN-SL-PL using the PATS-LINK cable.</p>

Fonctionnel if equipped

- | | | | |
|--|--|---|--|
| <input checked="" type="checkbox"/> Verrouillage | <input checked="" type="checkbox"/> Tach | <input checked="" type="checkbox"/> Radio Off | <input type="checkbox"/> Sièges chauffants |
| <input checked="" type="checkbox"/> Déverrouillage | <input checked="" type="checkbox"/> Active Démarreur | <input type="checkbox"/> Transponder Bypass | <input type="checkbox"/> Porte essence |
| <input checked="" type="checkbox"/> Armement | <input checked="" type="checkbox"/> Status de Porte | <input type="checkbox"/> PK3, Passlock | <input type="checkbox"/> Contrôle fenêtre |
| <input checked="" type="checkbox"/> Désarmement | <input checked="" type="checkbox"/> Status de Valise | <input type="checkbox"/> Portes Coulissantes | <input type="checkbox"/> Hayon arrière |
| <input checked="" type="checkbox"/> Valise | <input type="checkbox"/> Status de Capot | <input type="checkbox"/> Dégivrage | <input type="checkbox"/> Signal de Frein |

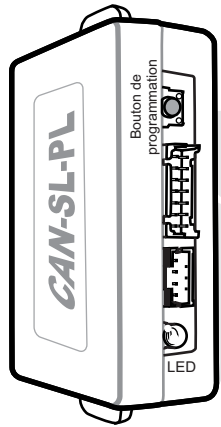

vue de face du module

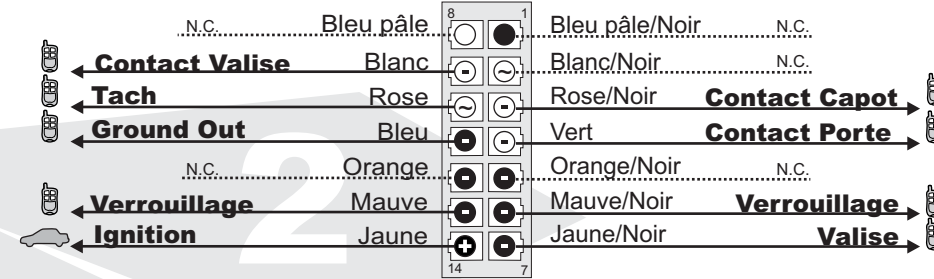

conn.

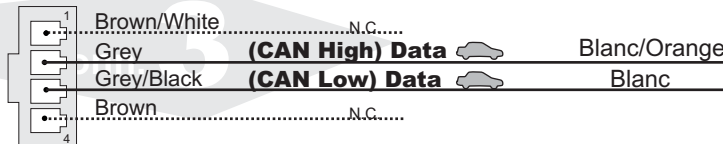
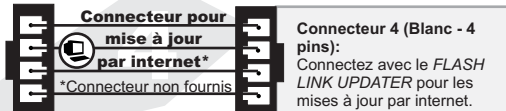
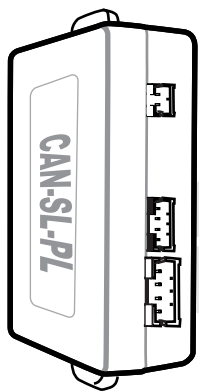
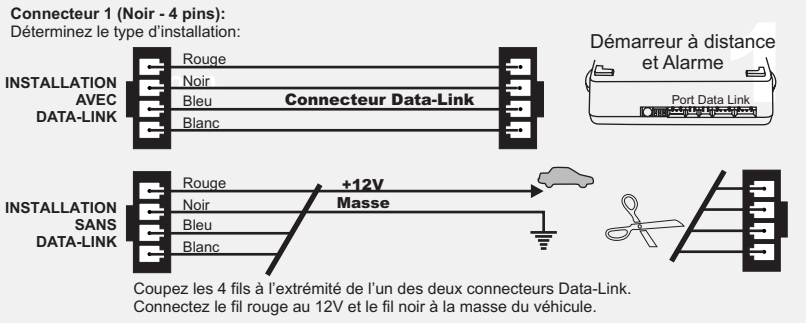

Paire de fils torsadés situés au connecteur d'ignition

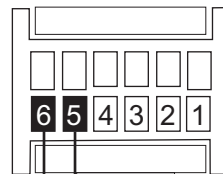

Branchement du filage au démarreur à distance/Alarme Branchement du filage au véhicule ○ SORTIE ● ENTRÉE

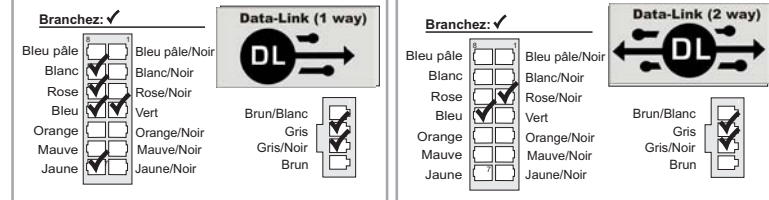

1 **1.A** **Connecteur 1 (Noir):**
Déterminez le type d'installation (Data-Link ou non Data-Link) Pour l'installation DATA-LINK assurez vous de la présence du connecteur DATA-LINK sur le démarreur.. Pour installation non Data-Link voir INSTALLATION SANS DATA-LINK.

1.B **Connecteur 2 (Blanc):**
Effectuez les branchements

1.C **Connecteur 3 (Blanc, situé au dos du module):**
Effectuez les branchements

2 **Maintenez le bouton de programmation enfoncé** en insérant le **connecteur 1** dans le CAN-SL-PL. Le DEL s'allume pour indiquer le début de la programmation, **relâchez le bouton de programmation.**

3 Branchez le connecteur 2 (**CONN. 2**)
ATTENTION: Ne pas brancher le connecteur à l'envers.

4 Branchez le connecteur 3 (**CONN. 3**)

5 Tournez la clef en position **ignition.**

6 Lorsque le DEL clignote rapidement, **tournez la clef en position OFF.**
Le DEL s'éteint pour indiquer que le module est programmé.

7 Le DEL clignotera jusqu'à ce que vous pressiez le bouton Verrouillage (Lock) de la télécommande d'origine du véhicule. **Le DEL s'éteint pour indiquer que le module est programmé.**

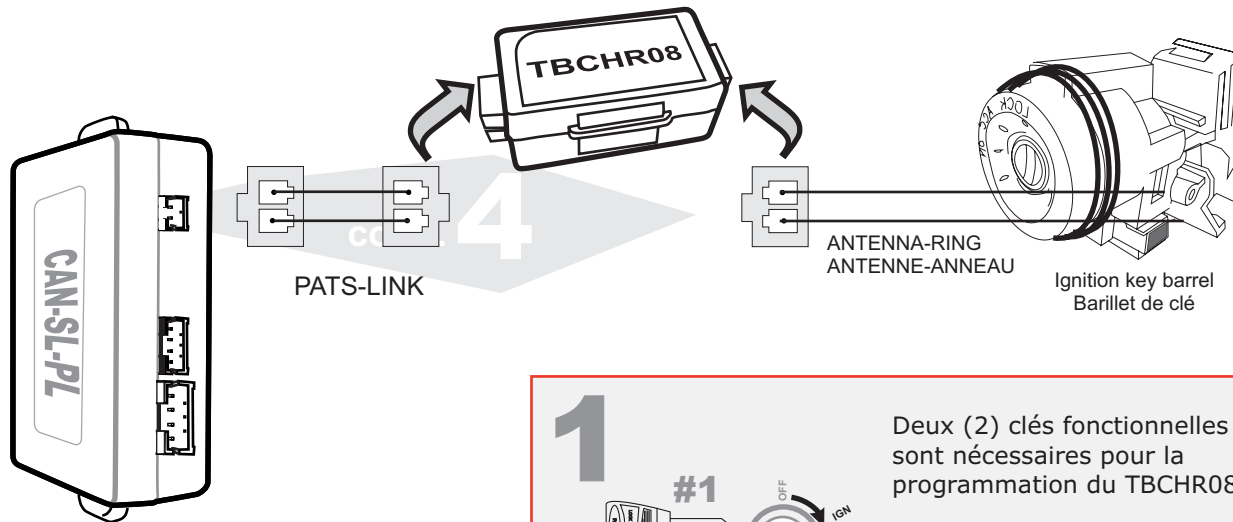

1

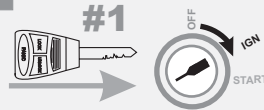

Deux (2) clés fonctionnelles sont nécessaires pour la programmation du TBCHR08.

Introduisez **la première clé** dans le contact et placez-la à la position **ON pendant 10 secondes.**

2

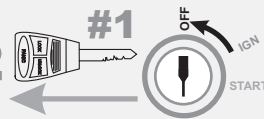

Tournez la clé à OFF et retirez la clé.

3

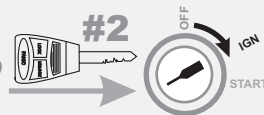

Introduisez la **deuxième (2) clé fonctionnelle** dans le contact et placez-la à **ON dans les 10 secondes** qui suivent.

4

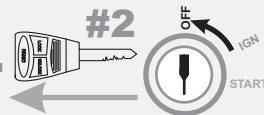

Tournez la clé à OFF et retirez la clé.



Vous avez 60 secondes pour effectuer les étapes suivantes

5

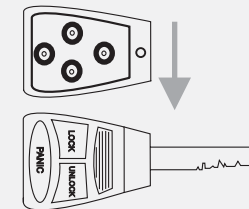

➤ Enlevez le couvercle arrière et le circuit interne d'une des clés-télécommandes.

➤ Placez la clé-télécommande vide (sans circuit interne) **contre le TBCHR08.**

➤ **Maintenir les 2 pièces côte à côte** en introduisant la clé-télécommande dans le contact et **tournez-les** à la position **ON.**

6

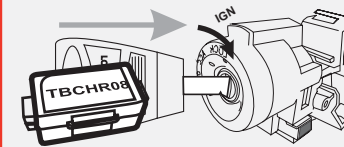

➤ **Après 15 secondes** le témoin **SECURITY (ou Check Engine)** cessera de clignoter et une tonalité se fera entendre.

➤ Tournez l'ignition en position OFF et retirez la clé. Si la programmation échoue, attendez 3 à 5 minutes avant de recommencer la procédure.

➤ **Le TBCHR08 est programmé.**

➤ Réassemblez la clé.

7

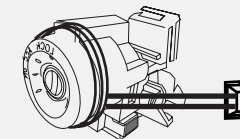

Enroulez les fils du connecteur noir autour de barillet d'ignition 3 à 4 tours pour un fonctionnement optimal. (Sécurisez avec une attache de nylon)

8

Branchez le module TBCHR08 dans le module CAN-SL-PL en utilisant le câble PATS-LINK.