



KIA Sedona

2006-2009



CAN-SL-PL and TBKIA1

Made in Canada Rev. A - 14 / 01 / 2009

Web site: <http://www.ifar.ca>

ALARM AND REMOTE STARTER CAN BUS INTERFACE KIT

Fonctionnal if equipped

- | | | | |
|--|---|--|---|
| <input checked="" type="checkbox"/> Lock | <input type="checkbox"/> Tach | <input type="checkbox"/> Radio Off | <input type="checkbox"/> Heat Seats |
| <input checked="" type="checkbox"/> Unlock | <input type="checkbox"/> Start Enable | <input type="checkbox"/> Transponder Bypass | <input type="checkbox"/> Gas Door |
| <input checked="" type="checkbox"/> Arm | <input checked="" type="checkbox"/> Door Trigger | <input type="checkbox"/> PK3, Passlock | <input type="checkbox"/> Window Roll Down |
| <input checked="" type="checkbox"/> Disarm | <input checked="" type="checkbox"/> Trunk Trigger | <input checked="" type="checkbox"/> Sliding Door | <input type="checkbox"/> Hatch |
| <input checked="" type="checkbox"/> Trunk | <input type="checkbox"/> Hood Trigger | <input type="checkbox"/> Defrost | <input type="checkbox"/> Brake Signal |

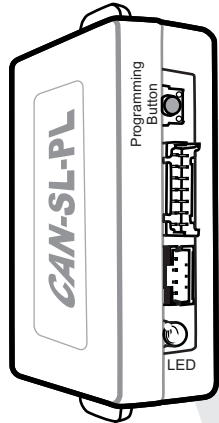

Front of the module

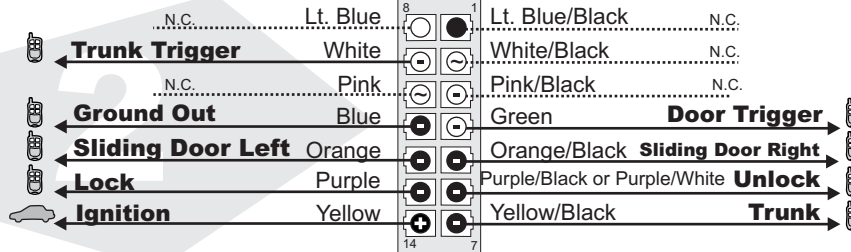

1

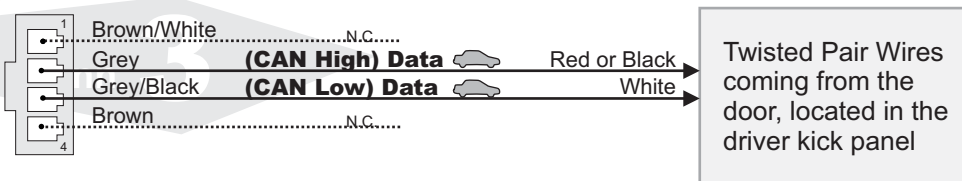
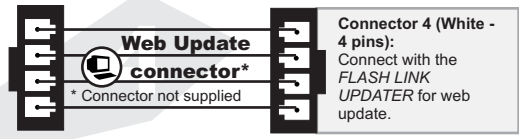
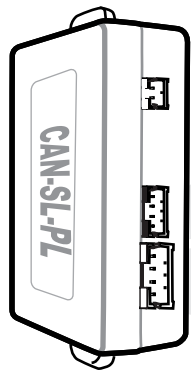
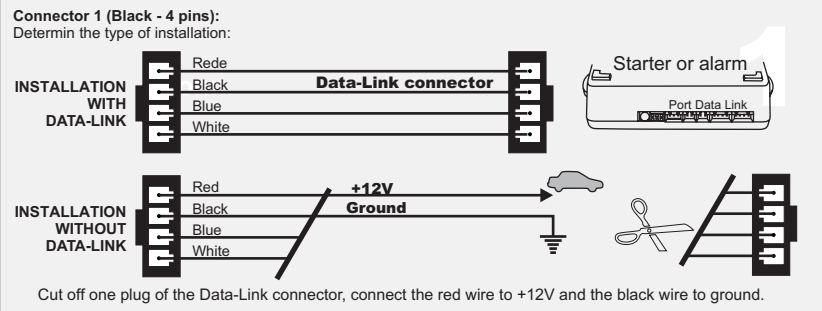

Connect wire to Remote-Starter/Alarm
 Connect wire to vehicle
 ○ OUTPUT
● INPUT

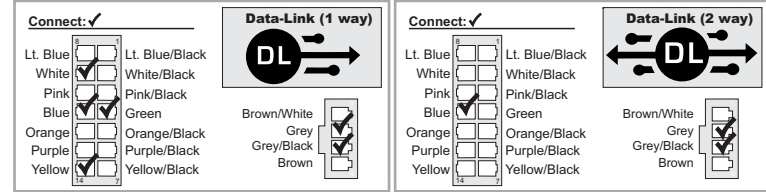

- 1.1.A** Connector 1 (Black): Determine the type of installation: INSTALLATION WITH DATA-LINK / INSTALLATION WITHOUT DATA-LINK
- 1.1.B** Connector 2 (White): Make the connections
- 1.1.C** Connector 3 (White, located at the back of the module): Make the connections
- 2** Press the programming switch while inserting the main wires harness (CONN 1) into the CAN-SL-PL module. The LED will illuminate to indicate you are in programming mode, release the programming button.
- 3** Connect the other connectors (CONN. 2) **WARNING: Connector 2 can be easily plugged in backwards.**
- 4** Connect the other connectors (CONN. 3)
- 5** Turn the key to the "ON" position.
- 6** Once the LED starts to flash rapidly turn the key to the OFF position. The LED will turn off to indicate the module has been programmed. **The module is now ready for use.**



Technical support:
 TEL: 514-255-HELP (4357)
 FAX: 514-255-1367
 Web: www.ifar.ca

Neither the manufacturer or distributor of this module is responsible of damages of any kind indirectly or directly caused by this module, except for the replacement of this module in case of manufacturing defects. This module must be install by qualified technician. This instruction guide may change without notice. Visit www.ifar.ca to get latest version.



KIA Sedona

2006-2009



CAN-SL-PL and TBKIA1

Made in Canada Rev. A - 14 / 01 / 2009
Web site: <http://www.ifar.ca>



You must have all keys available. (3 keys)



DEALER SCAN TOOL and associated cartridge is required for programming.

IMPORTANT : The TBKIA1 can only be programmed once. Once the TBKIA1 is programmed, it can't be programmed or used on any other vehicle.

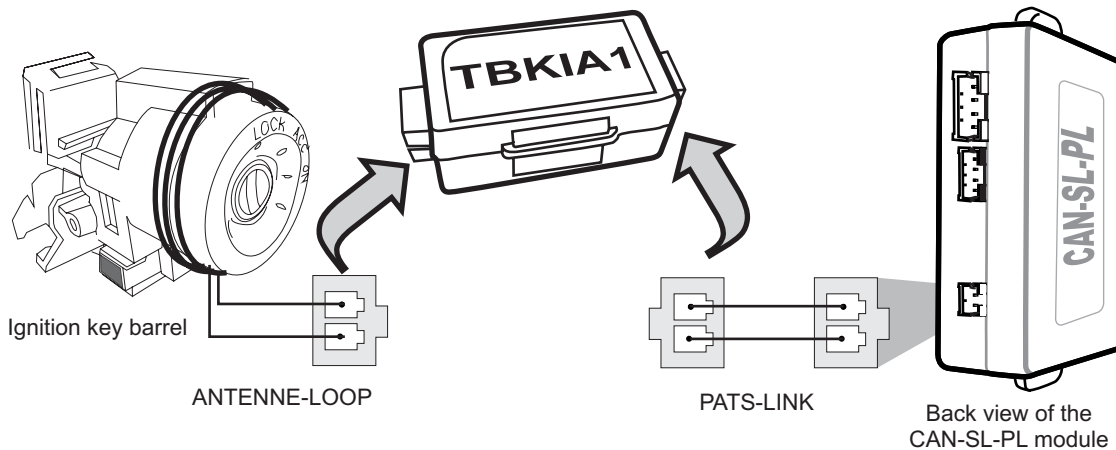

1

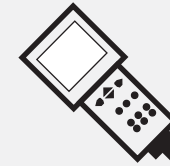

A DEALER SCAN TOOL IS REQUIRED TO PROGRAM THE TBKIA1 MODULE. A QUALIFIED TECHNICIAN FROM THE DEALERSHIP SHOULD PERFORM STEP 1 AND 4 BELOW.

Hook up the SCAN TOOL

Follow the key programming procedure on the DEALER SCAN TOOL.

2

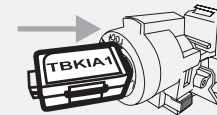

Place the TBKIA1 close to the front of the ignition barrel for the next 2 steps.

3

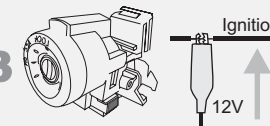

Power up the vehicles ignition using a jumper wire.

4

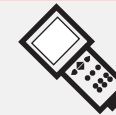

Follow the instructions on the DEALER SCAN TOOL.

5

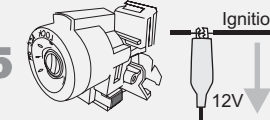

Remove the jumper wire.

6

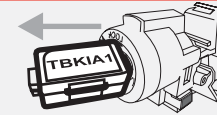

Remove TBKIA1 module.

7



Ensure all of the customers keys are still functional.

8

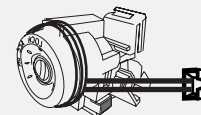

Make 3 to 4 loops around the ignition barrel with the antenna-loop.
(Secure the wire with tie-wrap.)

9

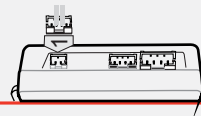

Connect the TBKIA1 module to the CAN-SL-PL using the PATS-LINK cable.

10

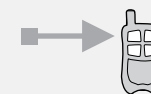

Remote start the vehicle.

The module TBKIA1 is now programmed.



Neither the manufacturer or distributor of this module is responsible of damages of any kind indirectly or directly caused by this module, except for the replacement of this module in case of manufacturing defects. This module must be install by qualified technician. This instruction guide may change without notice. Visit www.ifar.ca to get latest version.



KIA Sedona

2006-2009



CAN-SL-PL et TBKIA1

Fabriqu  au Canada Rev. A - 14 / 01 / 2009
Site internet <http://www.ifar.ca>

MODULE D'INTERFACE CAN BUS POUR ALARME ET D MARREUR   DISTANCE

Fonctionnel if equipped

<input checked="" type="checkbox"/> Verrouillage	<input type="checkbox"/> Tach	<input type="checkbox"/> Radio Off	<input type="checkbox"/> Si�ges chauffants
<input checked="" type="checkbox"/> D�verrouillage	<input checked="" type="checkbox"/> Active D�marreur	<input type="checkbox"/> Transponder Bypass	<input type="checkbox"/> Porte essence
<input checked="" type="checkbox"/> Armement	<input checked="" type="checkbox"/> Status de Porte	<input type="checkbox"/> PK3, Passlock	<input type="checkbox"/> Contr�le portes
<input checked="" type="checkbox"/> D�sarmement	<input checked="" type="checkbox"/> Status de Valise	<input checked="" type="checkbox"/> Portes Coulisssantes	<input type="checkbox"/> Hayon arri�re
<input checked="" type="checkbox"/> Valise	<input type="checkbox"/> Status de Capot	<input type="checkbox"/> D�givrage	<input type="checkbox"/> Signal de Frein

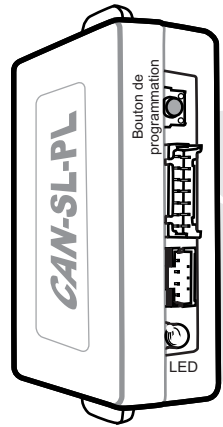

vue de face du module

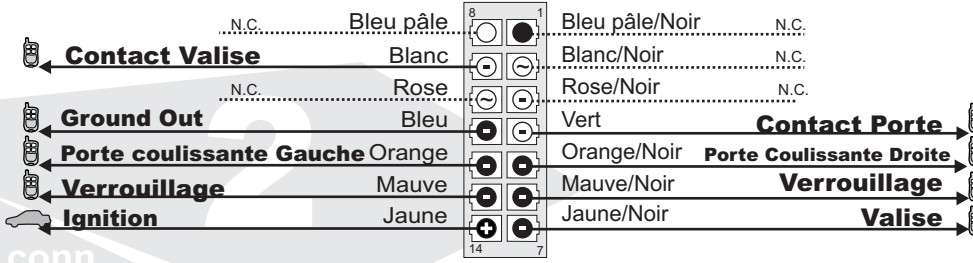

1

conn.

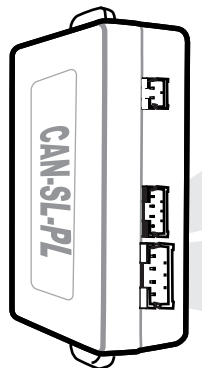
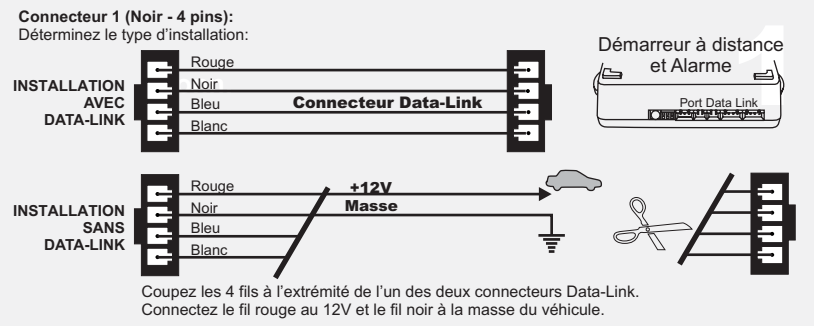

vue de dos du module

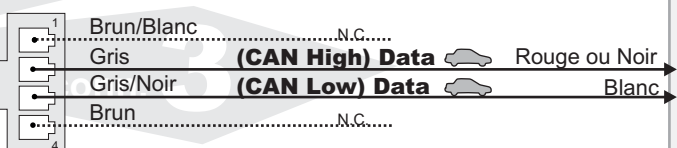
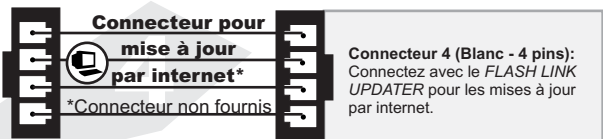

Paire de fils torsad s provenant de la porte, situ e dans le panneau lat ral de la porte du c t  chauffeur.

Branchement du filage au d marreur   distance/Alarme Branchement du filage au v hicule SORTIE ENTR E

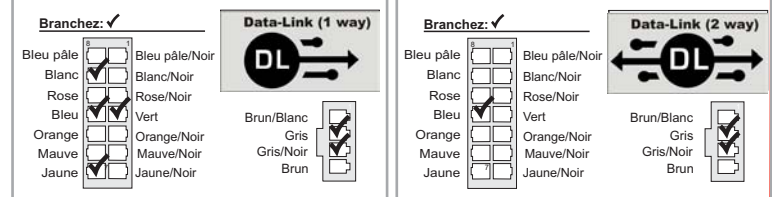

Effectuez les connexions du CAN-SL-PL au v hicule:

- 1.A** **Connecteur 1 (Noir):**
D terminez le type d'installation (Data-Link ou non Data-Link) Pour l'installation DATA-LINK assurez vous de la pr sence du connecteur DATA-LINK sur le d marreur.. Pour installation non Data-Link voir INSTALLATION SANS DATA-LINK.
- 1.B** **Connecteur 2 (Blanc):**
Effectuez les branchements
- 1.C** **Connecteur 3 (Blanc, situ  au dos du module):**
Effectuez les branchements
- 2** **Maintenez le bouton de programmation enfonc ** en ins rant le **connecteur 1** dans le CAN-SL-PL. Le DEL s'allume pour indiquer le d but de la programmation, **rel chez le bouton de programmation.**
- 3** Branchez le connecteur 2 (**CONN. 2**)

ATTENTION: Ne pas brancher le connecteur   l'envers.
- 4** Branchez le connecteur 3 (**CONN. 3**)
- 5** Tournez la clef en position **ignition.**
- 6** Lorsque le DEL clignote rapidement, **tournez la clef en position OFF.**

Le DEL s' teint pour indiquer que le module est programm .



Support Technique:
TEL: 514-255-HELP (4357)
FAX: 514-255-1367
Site internet: www.ifar.ca

Ni le manufacturier, ni le distributeur ne se consid rent responsables des dommages caus s ou ayant pu  tre caus s, indirectement ou directement, par ce module, except  le remplacement de ce module en cas de d fectuosit  de fabrication. Ce module doit  tre install  par un technicien qualifi . Ce guide d'instruction peut faire l'objet de changement sans pr avis. Consultez le www.ifar.ca pour voir la plus r cente version.



KIA Sedona

2006-2009

MISE À JOUR
PAR INTERNET

CAN-SL-PL et TBKIA1
Fabriqué au Canada Rev. A - 14 / 01 / 2009
Site internet <http://www.ifar.ca>

MODULE D'INTERFACE CAN BUS POUR ALARME ET DÉMARREUR À DISTANCE



Vous devez avoir toutes les clés du véhicule. (3 clés)



Vous avez besoin du SCAN TOOL de KIA avec le cartouche approprié pour la programmation des clés.

IMPORTANT : Vous pouvez programmer le TBKIA1 qu'une seule fois.
Une fois le TBKIA1 programmé, il ne peut être reprogrammé ou utilisé sur un autre véhicule.

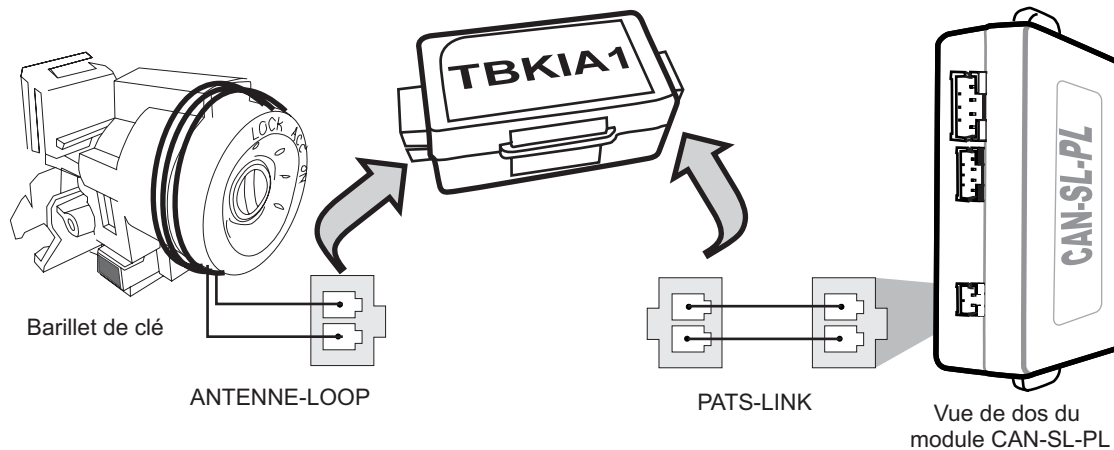

1

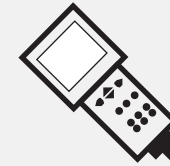

LE SCAN TOOL DU CONCESSIONNAIRE EST REQUIS POUR LA PROGRAMMATION DES CLÉS. UN TECHNICIEN QUALIFIÉ DU CONCESSIONNAIRE DEVRAIT EFFECTUER CETTE ÉTAPE ET L'ÉTAPE 4.

Branchez le SCAN TOOL

Suivre les indications du SCAN TOOL pour reprogrammer tous les clés (procedure teaching).

2

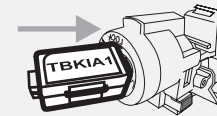

Placez le TBKIA1 devant le barillet d'ignition pour les 2 prochaines étapes.

3

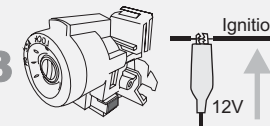

À l'aide d'un fil (jumper), alimentez l'ignition manuellement

4

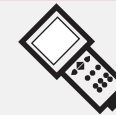

Suivez les instructions du DEALER SCAN TOOL.

5

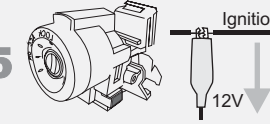

Retirez le fil (jumper)

6

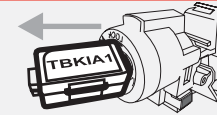

Retirez le module TBKIA1.

7



Il est important de réessayer chaque clé du véhicule.

8

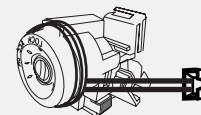

Enroulez les fils de l'antenne autour de barillet d'ignition 3 à 4 tours pour un fonctionnement optimal. (Sécurisez avec une attache de nylon)

9

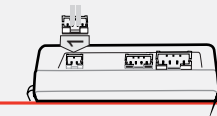

Branchez le module TBKIA1 dans le module CAN-SL-PL avec le câble PATS-LINK.

10

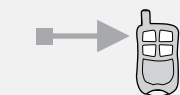

Démarrez la voiture avec le démarreur à distance.

Le module TBKIA1 est maintenant programmé.



Ni le manufacturier, ni le distributeur ne se considèrent responsables des dommages causés ou ayant pu être causés, indirectement ou directement, par ce module, excepté le remplacement de ce module en cas de défectuosité de fabrication. Ce module doit être installé par un technicien qualifié. Ce guide d'instruction peut faire l'objet de changement sans préavis. Consultez le www.ifar.ca pour voir la plus récente version.