



CHEVROLET Cobalt

2007-2009



CAN-SL2

Made in Canada Rev. A - 01 / 02 / 2009
Web site: <http://www.ifar.ca>

ALARM AND REMOTE STARTER CAN BUS INTERFACE KIT

Fonctionnal if equipped

- | | | | |
|--|---|--|---|
| <input checked="" type="checkbox"/> Lock | <input checked="" type="checkbox"/> Tach | <input type="checkbox"/> Radio Off | <input type="checkbox"/> Heat Seats |
| <input checked="" type="checkbox"/> Unlock | <input checked="" type="checkbox"/> Start Enable | <input checked="" type="checkbox"/> Transponder Bypass | <input type="checkbox"/> Gas Door |
| <input checked="" type="checkbox"/> Arm | <input checked="" type="checkbox"/> Door Trigger | <input checked="" type="checkbox"/> PK3, Passlock | <input type="checkbox"/> Window Roll Down |
| <input checked="" type="checkbox"/> Disarm | <input checked="" type="checkbox"/> Trunk Trigger | <input type="checkbox"/> Sliding Door | <input type="checkbox"/> Hatch |
| <input checked="" type="checkbox"/> Trunk | <input type="checkbox"/> Hood Trigger | <input type="checkbox"/> Defrost | <input type="checkbox"/> Brake Signal |

WARNING: All Ignition and accessory wires of the remote starter must be connected at the ignition barrel.

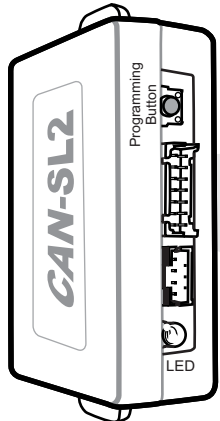

Front view of the module

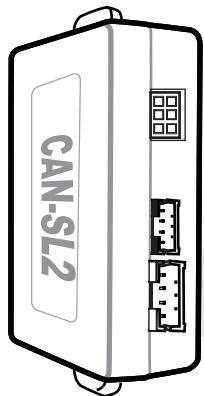

Back of the module

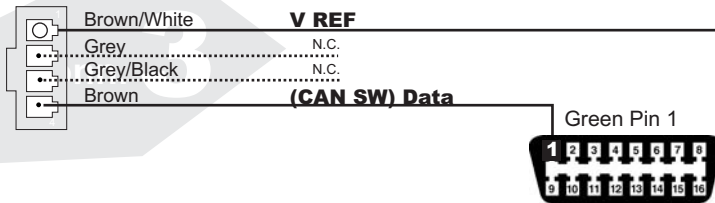
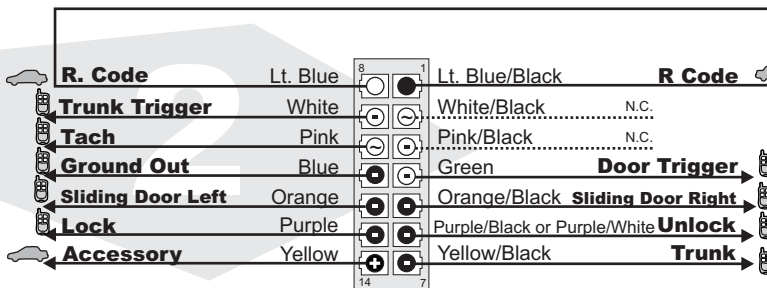

Connection for Transponder bypass.

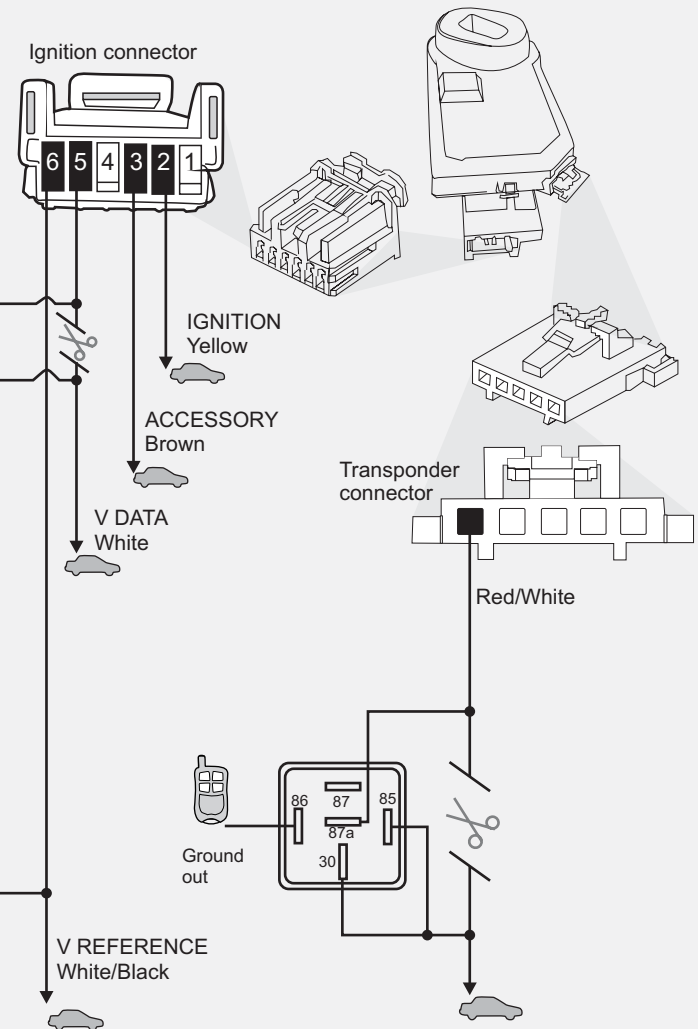

Connect wire to Remote-Starter/Alarm Connect wire to vehicle

○ OUTPUT ● INPUT



Technical support:
TEL: 514-255-HELP (4357)
FAX: 514-255-1367
Web: www.ifar.ca

Neither the manufacturer or distributor of this module is responsible of damages of any kind indirectly or directly caused by this module, except for the replacement of this module in case of manufacturing defects. This module must be install by qualified technician. This instruction guide may change without notice. Visit www.ifar.ca to get latest version.

Connect: ✓	Branchez: ✓	Data-Link (1 way)	Connect: ✓	Branchez: ✓	Data-Link (2 way)
Lt. Blue <input checked="" type="checkbox"/>	Lt. Blue/Black <input checked="" type="checkbox"/>		Lt. Blue <input checked="" type="checkbox"/>	Lt. Blue/Black <input checked="" type="checkbox"/>	
White <input checked="" type="checkbox"/>	White/Black <input checked="" type="checkbox"/>		White <input checked="" type="checkbox"/>	White/Black <input checked="" type="checkbox"/>	
Pink <input checked="" type="checkbox"/>	Pink/Black <input checked="" type="checkbox"/>		Pink <input checked="" type="checkbox"/>	Pink/Black <input checked="" type="checkbox"/>	
Blue <input checked="" type="checkbox"/>	Green <input checked="" type="checkbox"/>		Blue <input type="checkbox"/>	Green <input type="checkbox"/>	
Orange <input type="checkbox"/>	Orange/Black <input type="checkbox"/>		Orange <input type="checkbox"/>	Orange/Black <input type="checkbox"/>	
Purple <input checked="" type="checkbox"/>	Purple/Black <input checked="" type="checkbox"/>		Purple <input type="checkbox"/>	Purple/Black <input type="checkbox"/>	
Yellow <input checked="" type="checkbox"/>	Yellow/Black <input checked="" type="checkbox"/>		Yellow <input checked="" type="checkbox"/>	Yellow/Black <input checked="" type="checkbox"/>	
		Brown/White <input checked="" type="checkbox"/>			Brown/White <input checked="" type="checkbox"/>
		Grey <input checked="" type="checkbox"/>			Grey <input checked="" type="checkbox"/>
		Grey/Black <input checked="" type="checkbox"/>			Grey/Black <input checked="" type="checkbox"/>
		Brown <input type="checkbox"/>			Brown <input type="checkbox"/>



CHEVROLET Cobalt

2007-2009



CAN-SL2

Made in Canada Rev. B - 01 / 02 / 2009
Web site: <http://www.ifar.ca>

ALARM AND REMOTE STARTER CAN BUS INTERFACE KIT

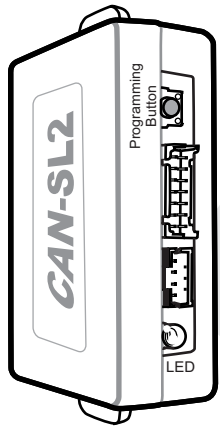

Front view of the module

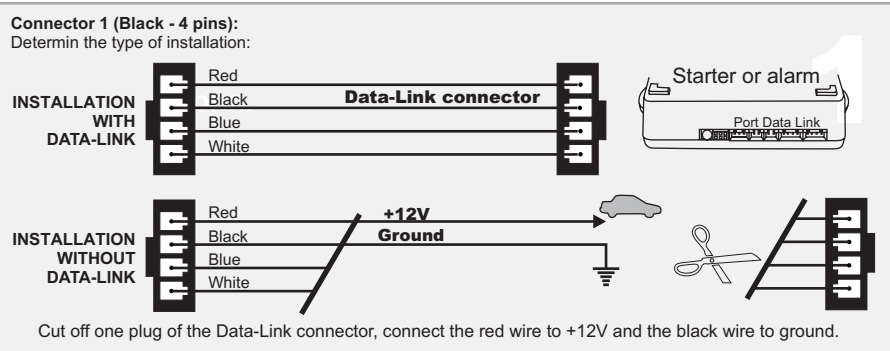

1 **1.A** **Make the connections of the CAN-SL2 to the vehicle:**

Connector 1 (Black):
Determine the type of installation:
INSTALLATION WITH DATA-LINK
INSTALLATION WITHOUT DATA-LINK

1.B **Connector 2 (White):**
Make the connections

1.C **Connector 3 (White, located at the back of the module):**
Make the connections

2 **Press the programming switch while inserting the main wires harness (CONN 1) into the CAN-SL2 module.**
The LED will illuminate to indicate you are in programming mode, release the programming button.

3 **Connect the other connectors (CONN. 2)**
WARNING: Connector 2 can be easily plugged in backwards.

4 **Connect the other connectors (CONN. 3)**

5 Turn the key to the "ON" position.

6 Once the LED starts to flash rapidly turn the key to the **OFF** position.
The LED will turn off to indicate the module has been programmed.
The module is now ready for use.

Connect wire to Remote-Starter/Alarm Connect wire to vehicle

○ OUTPUT ● INPUT



Technical support:
TEL: 514-255-HELP (4357)
FAX: 514-255-1367
Web: www.ifar.ca

Neither the manufacturer or distributor of this module is responsible of damages of any kind indirectly or directly caused by this module, except for the replacement of this module in case of manufacturing defects. This module must be install by qualified technician. This instruction guide may change without notice. Visit www.ifar.ca to get latest version.



CHEVROLET Cobalt

2007-2009



CAN-SL2

Fabriqu  au Canada Rev.B - 01 / 02 / 2009
Site internet <http://www.ifar.ca>

MODULE D'INTERFACE CAN BUS POUR ALARME ET D MARREUR   DISTANCE

Fonctionnel si  quipp 

- | | | | |
|--|--|--|--|
| <input checked="" type="checkbox"/> Verrouillage | <input checked="" type="checkbox"/> Tach | <input type="checkbox"/> Radio Off | <input type="checkbox"/> Si ges chauffants |
| <input checked="" type="checkbox"/> D verrouillage | <input checked="" type="checkbox"/> Active D marreur | <input checked="" type="checkbox"/> Transponder Bypass | <input type="checkbox"/> Porte essence |
| <input checked="" type="checkbox"/> Armement | <input checked="" type="checkbox"/> Status de Porte | <input checked="" type="checkbox"/> PK3, Passlock | <input type="checkbox"/> Contr le fen tres |
| <input checked="" type="checkbox"/> D sarmement | <input checked="" type="checkbox"/> Status de Valise | <input type="checkbox"/> Portes Coulissantes | <input type="checkbox"/> Hayon arri re |
| <input checked="" type="checkbox"/> Valise | <input checked="" type="checkbox"/> Status de Capot | <input type="checkbox"/> D givrage | <input type="checkbox"/> Signal de Frein |

ATTENTION: Les fils d'ignition et d'accessoire du d marreur   distance doivent  tre connect s au barillet d'ignition.

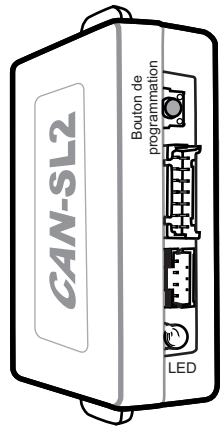

vue de face du module

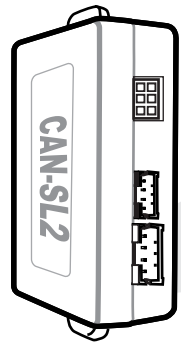

Vue de dos du module

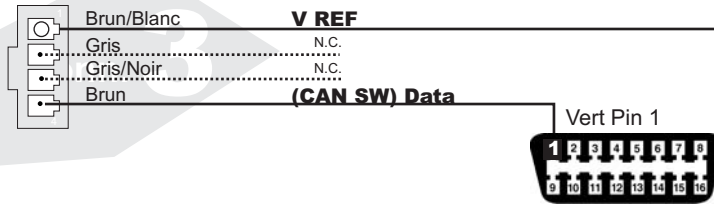
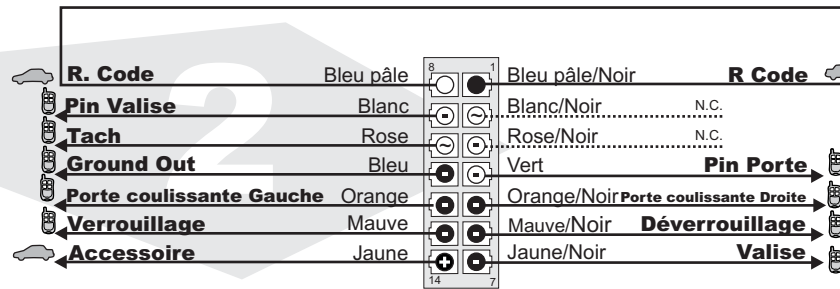

Connexion pour le contournement transponder.

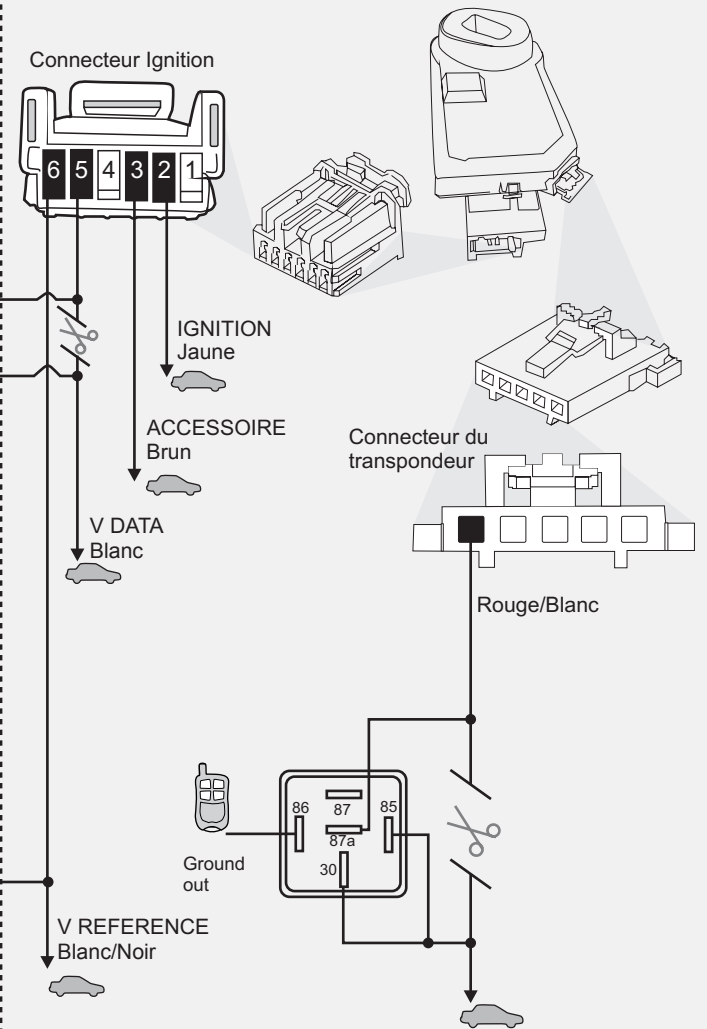

Branchement du filage au d marreur   distance/Alarme Branchement du filage au v hicule ○ SORTIE ● ENTR E



Support Technique:
TEL: 514-255-HELP (4357)
FAX: 514-255-1367
Site internet: www.ifar.ca

Ni le manufacturier, ni le distributeur ne se consid rent responsables des dommages caus s ou ayant pu  tre caus s, indirectement ou directement, par ce module, except  le remplacement de ce module en cas de d fectuosit  de fabrication. Ce module doit  tre install  par un technicien qualifi . Ce guide d'instruction peut faire l'objet de changement sans pr avis. Consultez le www.ifar.ca pour voir la plus r cente version.

<p>Branchez: ✓</p> <p>Bleu p�le <input checked="" type="checkbox"/></p> <p>Blanc <input checked="" type="checkbox"/></p> <p>Rose <input checked="" type="checkbox"/></p> <p>Bleu <input checked="" type="checkbox"/></p> <p>Orange <input checked="" type="checkbox"/></p> <p>Mauve <input checked="" type="checkbox"/></p> <p>Jaune <input checked="" type="checkbox"/></p>	<p>Data-Link (1 way)</p> <p>DL</p> <p>Brun/Blanc <input checked="" type="checkbox"/></p> <p>Gris <input checked="" type="checkbox"/></p> <p>Gris/Noir <input checked="" type="checkbox"/></p> <p>Brun <input checked="" type="checkbox"/></p>	<p>Branchez: ✓</p> <p>Bleu p�le <input checked="" type="checkbox"/></p> <p>Blanc <input checked="" type="checkbox"/></p> <p>Rose <input checked="" type="checkbox"/></p> <p>Bleu <input checked="" type="checkbox"/></p> <p>Orange <input checked="" type="checkbox"/></p> <p>Mauve <input checked="" type="checkbox"/></p> <p>Jaune <input checked="" type="checkbox"/></p>	<p>Data-Link (2 way)</p> <p>DL</p> <p>Brun/Blanc <input checked="" type="checkbox"/></p> <p>Gris <input checked="" type="checkbox"/></p> <p>Gris/Noir <input checked="" type="checkbox"/></p> <p>Brun <input checked="" type="checkbox"/></p>
---	---	---	---

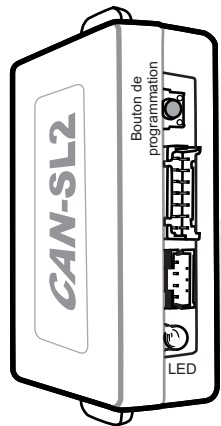

vue de face du module

Connecteur 1 (Noir - 4 pins):
Déterminez le type d'installation:

**INSTALLATION
AVEC
DATA-LINK**

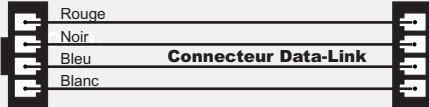

**INSTALLATION
SANS
DATA-LINK**

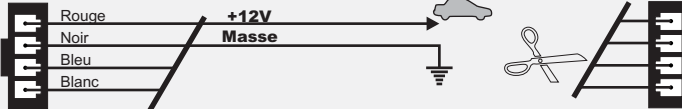

Coupez les 4 fils à l'extrémité de l'un des deux connecteurs Data-Link.
Connectez le fil rouge au 12V et le fil noir à la masse du véhicule.



1 **1.A** **Effectuez les connexions du CAN-SL2 au véhicule:**

Connecteur 1 (Noir):
Déterminez le type d'installation (**Data-Link** ou **non Data-Link**)
Pour l'installation DATA-LINK assurez vous de la présence du connecteur DATA-LINK sur le démarreur..
Pour installation non Data-Link voir INSTALLATION SANS DATA-LINK.



1.B **Connecteur 2 (Blanc):**
Effectuez les branchements



1.C **Connecteur 3 (Blanc, situé au dos du module):**
Effectuez les branchements



Maintenez le bouton de programmation enfoncé en insérant le **connecteur 1** dans le CAN-SL2.
Le DEL s'allume pour indiquer le début de la programmation, **relâchez le bouton de programmation.**



Branchez le connecteur 2 (**CONN. 2**)

ATTENTION: Ne pas brancher le connecteur à l'envers.



Branchez le connecteur 3 (**CONN. 3**)



Tournez la clef en position **ignition**.

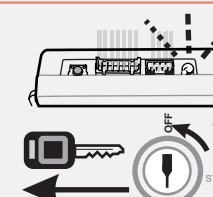

Lorsque le DEL clignote rapidement, **tournez la clef en position OFF.**

Le DEL s'éteint pour indiquer que le module est programmé.



Branchement du filage au démarreur à distance/Alarme



Branchement du filage au véhicule ○ SORTIE ● ENTRÉE