



# CHEVROLET Tahoe

2007-2009



## CAN-SL2

Made in Canada Rev. A - 01 / 02 / 2009  
Web site: <http://www.ifar.ca>

### ALARM AND REMOTE STARTER CAN BUS INTERFACE KIT

#### Fonctionnal if equipped

- |                                 |  |   |   |
|---------------------------------|--|---|---|
| <input type="checkbox"/> Lock   | <input type="checkbox"/> Tach          | <input type="checkbox"/> Radio Off          | <input type="checkbox"/> Heat Seats       |
| <input type="checkbox"/> Unlock | <input type="checkbox"/> Start Enable  | <input type="checkbox"/> Transponder Bypass | <input type="checkbox"/> Gas Door         |
| <input type="checkbox"/> Arm    | <input type="checkbox"/> Door Trigger  | <input type="checkbox"/> PK3, Passlock      | <input type="checkbox"/> Window Roll Down |
| <input type="checkbox"/> Disarm | <input type="checkbox"/> Trunk Trigger | <input type="checkbox"/> Sliding Door       | <input type="checkbox"/> Hatch            |
| <input type="checkbox"/> Trunk  | <input type="checkbox"/> Hood Trigger  | <input type="checkbox"/> Defrost            | <input type="checkbox"/> Brake Signal     |

**WARNING:** All Ignition and accessory wires of the remote starter must be connected at the ignition barrel.

**WARNING:** Every time the CAN-SL2 is disconnected, once reconnected the vehicle need to be started with the key.

#### Connection for Transponder bypass.

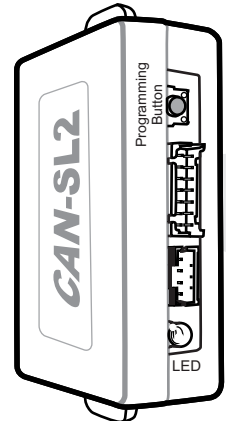

Front view of the module

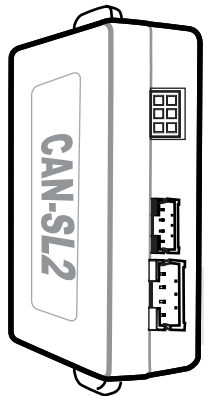

Back of the module

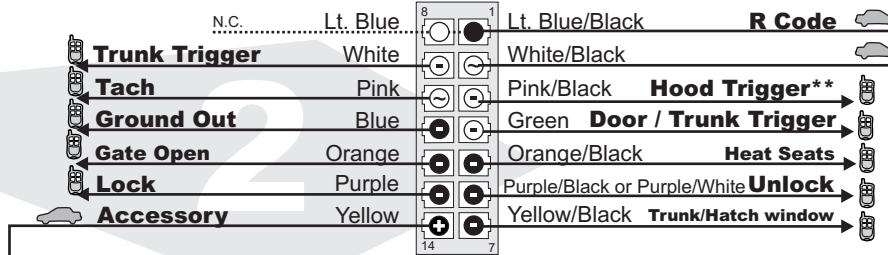

\*\* Only if the vehicle is equipped with a hood pin.

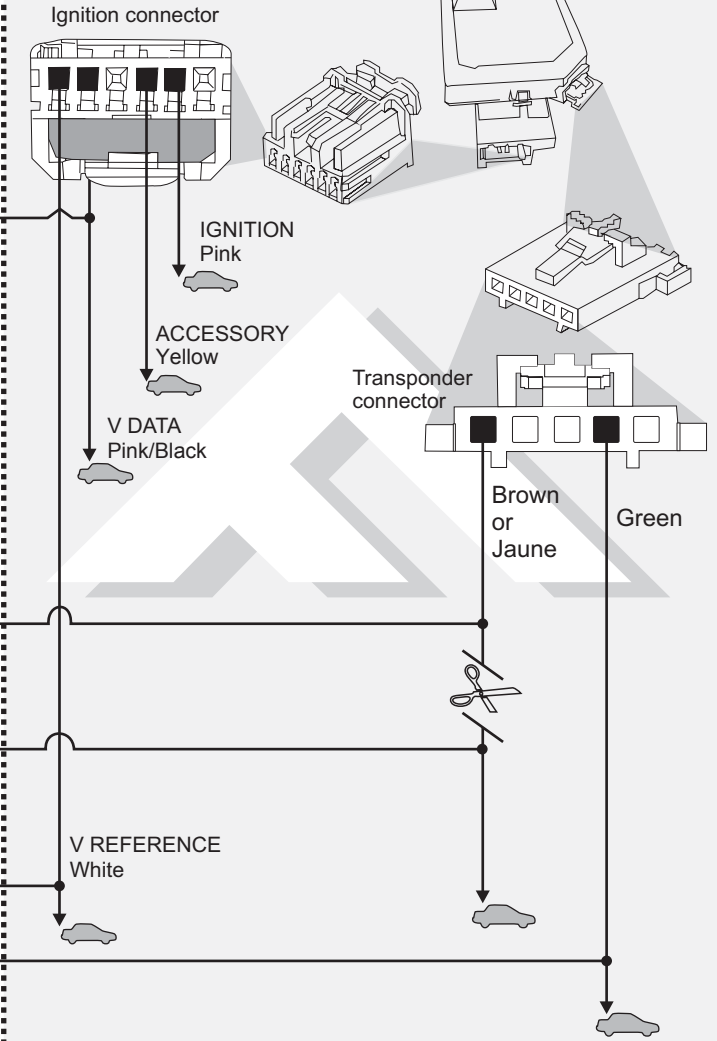

Connect wire to Remote-Starter/Alarm Connect wire to vehicle

○ OUTPUT ● INPUT

Connect: ✓	Branchez: ✓
Lt. Blue	Lt. Blue/Black
White	White/Black
Pink	Pink/Black
Blue	Green
Orange	Orange/Black
Purple	Purple/Black
Yellow	Yellow/Black

Data-Link (1 way)	
Brown/White	✓
Grey	✓
Grey/Black	✓
Brown	✓

Connect: ✓	Branchez: ✓
Lt. Blue	Lt. Blue/Black
White	White/Black
Pink	Pink/Black
Blue	Green
Orange	Orange/Black
Purple	Purple/Black
Yellow	Yellow/Black

Data-Link (2 way)	
Brown/White	✓
Grey	✓
Grey/Black	✓
Brown	✓



**Technical support:**  
TEL: 514-255-HELP (4357)  
FAX: 514-255-1367  
Web: [www.ifar.ca](http://www.ifar.ca)

Neither the manufacturer or distributor of this module is responsible of damages of any kind indirectly or directly caused by this module, except for the replacement of this module in case of manufacturing defects. This module must be install by qualified technician. This instruction guide may change without notice. Visit [www.ifar.ca](http://www.ifar.ca) to get latest version.

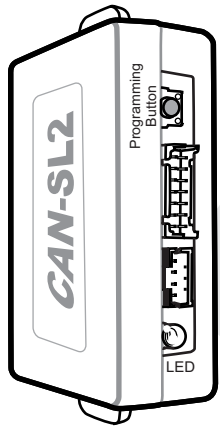

Front view of the module

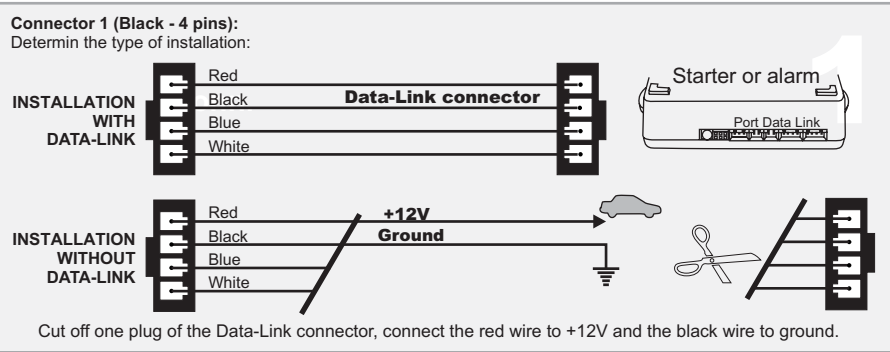

**1** **1.A** **Make the connections of the CAN-SL2 to the vehicle:**

**Connector 1 (Black):**  
Determine the type of installation:  
INSTALLATION WITH DATA-LINK  
INSTALLATION WITHOUT DATA-LINK

**1.B** **Connector 2 (White):**  
Make the connections

**1.C** **Connector 3 (White, located at the back of the module):**  
Make the connections

**2** **Press the programming switch while inserting the main wires harness (CONN 1) into the CAN-SL2 module.**  
The LED will illuminate to indicate you are in programming mode, release the programming button.

**3** **Connect the other connectors (CONN. 2)**  
**WARNING: Connector 2 can be easily plugged in backwards.**

**4** **Connect the other connectors (CONN. 3)**

**5** Turn the key to the **"ON" position.**

**6** Once the LED starts to flash rapidly turn the key to the **OFF position.**  
The LED will turn off to indicate the module has been programmed.

**The module is now ready for use.**

Connect wire to Remote-Starter/Alarm Connect wire to vehicle

○ OUTPUT ● INPUT



**Technical support:**  
TEL: 514-255-HELP (4357)  
FAX: 514-255-1367  
Web: [www.ifar.ca](http://www.ifar.ca)

Neither the manufacturer or distributor of this module is responsible of damages of any kind indirectly or directly caused by this module, except for the replacement of this module in case of manufacturing defects. This module must be install by qualified technician. This instruction guide may change without notice. Visit [www.ifar.ca](http://www.ifar.ca) to get latest version.



# CHEVROLET Tahoe

## 2007-2009



### CAN-SL2

Fabriqu  au Canada Rev.A - 01 / 02 / 2009  
Site internet <http://www.ifar.ca>

MODULE D'INTERFACE CAN BUS POUR ALARME ET D MARREUR   DISTANCE

#### Fonctionnel si  quipp 

- |   |   |  |  |
|---|---|--|--|
| <input type="checkbox"/> Verrouillage   | <input type="checkbox"/> Tach             | <input type="checkbox"/> Radio Off           | <input type="checkbox"/> Si ges chauffants |
| <input type="checkbox"/> D verrouillage | <input type="checkbox"/> Active D marreur | <input type="checkbox"/> Transponder Bypass  | <input type="checkbox"/> Porte essence     |
| <input type="checkbox"/> Armement       | <input type="checkbox"/> Status de Porte  | <input type="checkbox"/> PK3, Passlock       | <input type="checkbox"/> Contr le fen tres |
| <input type="checkbox"/> D sarmement    | <input type="checkbox"/> Status de Valise | <input type="checkbox"/> Portes Coulissantes | <input type="checkbox"/> Hayon arri re     |
| <input type="checkbox"/> Valise         | <input type="checkbox"/> Status de Capot  | <input type="checkbox"/> D givrage           | <input type="checkbox"/> Signal de Frein   |

**ATTENTION:** Les fils d'ignition et d'accessoire du d marreur   distance doivent  tre connect s au barillet d'ignition.

**ATTENTION:** Chaque fois que le CAN-SL2 est d branch , une fois le module rebranch , d marrez le v hicule avec la cl .

#### Connexions pour le contournement transpondeur.

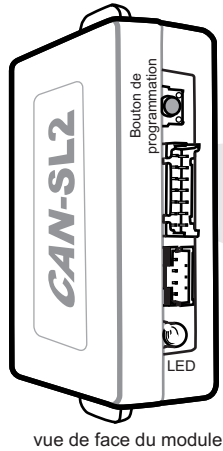

vue de face du module

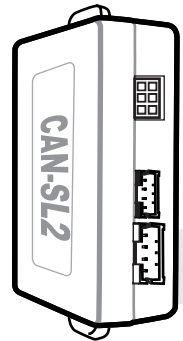

Vue de dos du module

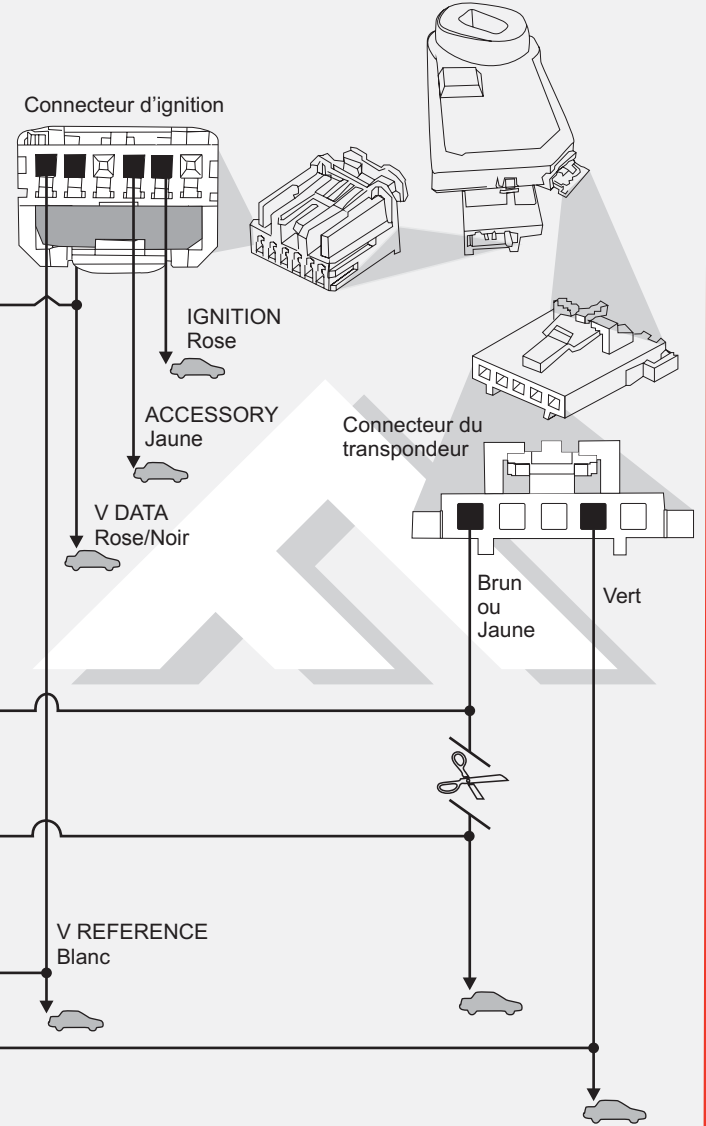
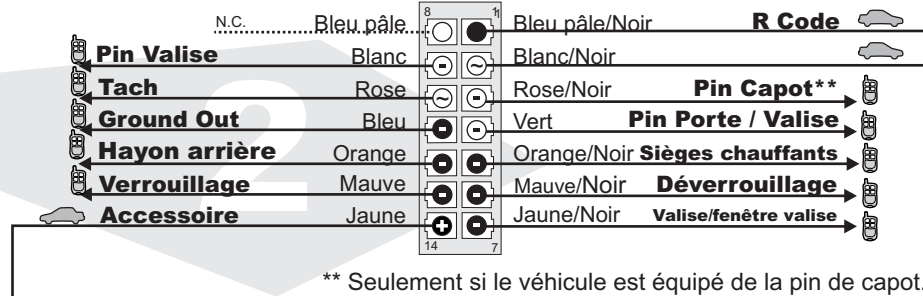

Branchement du filage au d marreur   distance/Alarme Branchement du filage au v hicule SORTIE ENTR E



**Support Technique:**  
TEL: 514-255-HELP (4357)  
FAX: 514-255-1367  
Site internet: [www.ifar.ca](http://www.ifar.ca)

Ni le manufacturier, ni le distributeur ne se consid rent responsables des dommages caus s ou ayant pu  tre caus s, indirectement ou directement, par ce module, except  le remplacement de ce module en cas de d fectuosit  de fabrication. Ce module doit  tre install  par un technicien qualifi . Ce guide d'instruction peut faire l'objet de changement sans pr avis. Consultez le [www.ifar.ca](http://www.ifar.ca) pour voir la plus r cente version.

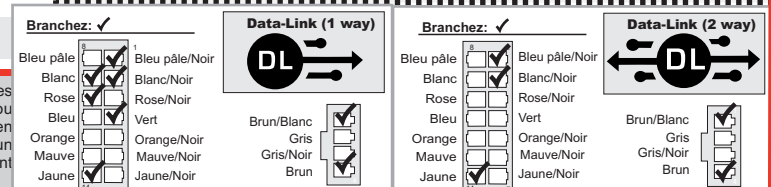

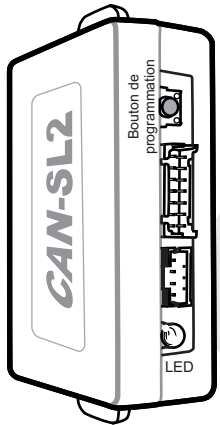

vue de face du module

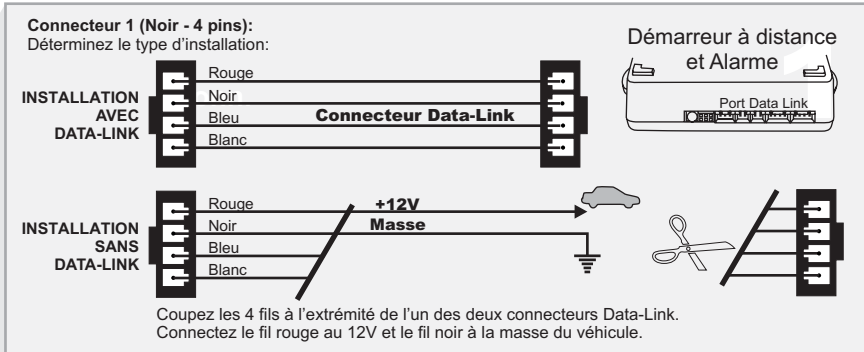

**1** **1.A** **Connecteur 1 (Noir):**  
Déterminez le type d'installation (**Data-Link** ou **non Data-Link**)  
Pour l'installation DATA-LINK assurez vous de la présence du connecteur DATA-LINK sur le démarreur..  
Pour installation non Data-Link voir INSTALLATION SANS DATA-LINK.

**1.B** **Connecteur 2 (Blanc):**  
Effectuez les branchements

**1.C** **Connecteur 3 (Blanc, situé au dos du module):**  
Effectuez les branchements

**2** **Maintenez le bouton de programmation enfoncé** en insérant le **connecteur 1** dans le CAN-SL2.  
Le DEL s'allume pour indiquer le début de la programmation, **relâchez le bouton de programmation.**

**3** Branchez le connecteur 2 (**CONN. 2**)  
**ATTENTION: Ne pas brancher le connecteur à l'envers.**

**4** Branchez le connecteur 3 (**CONN. 3**)

**5** Tournez la clef en position **ignition**.

**6** Lorsque le DEL clignote rapidement, **tournez la clef en position OFF.**  
**Le DEL s'éteint pour indiquer que le module est programmé.**

Branchement du filage au démarreur à distance/Alarme Branchement du filage au véhicule ○ SORTIE ● ENTRÉE