

Fonctionnal if equipped

- | | | | |
|---------------------------------|--|---|---|
| <input type="checkbox"/> Lock | <input type="checkbox"/> Tach | <input type="checkbox"/> Radio Off | <input type="checkbox"/> Heat Seats |
| <input type="checkbox"/> Unlock | <input type="checkbox"/> Start Enable | <input type="checkbox"/> Transponder Bypass | <input type="checkbox"/> Gas Door |
| <input type="checkbox"/> Arm | <input type="checkbox"/> Door Trigger | <input type="checkbox"/> PK3, Passlock | <input type="checkbox"/> Window Roll Down |
| <input type="checkbox"/> Disarm | <input type="checkbox"/> Trunk Trigger | <input type="checkbox"/> Sliding Door | <input type="checkbox"/> Hatch |
| <input type="checkbox"/> Trunk | <input type="checkbox"/> Hood Trigger | <input type="checkbox"/> Defrost | <input type="checkbox"/> Brake Signal |

WARNING: All Ignition and accessory wires of the remote starter must be connected at the ignition barrel.

WARNING: Every time the CAN-SL2 is disconnected, once reconnected the vehicle need to be started with the key.

Connection for Transponder bypass.

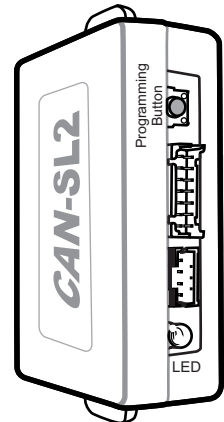

Front view of the module

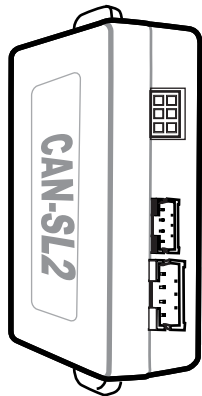

Back of the module

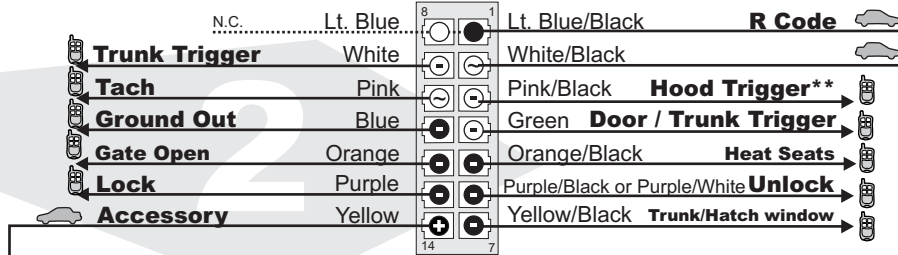

** Only if the vehicle is equipped with a hood pin.

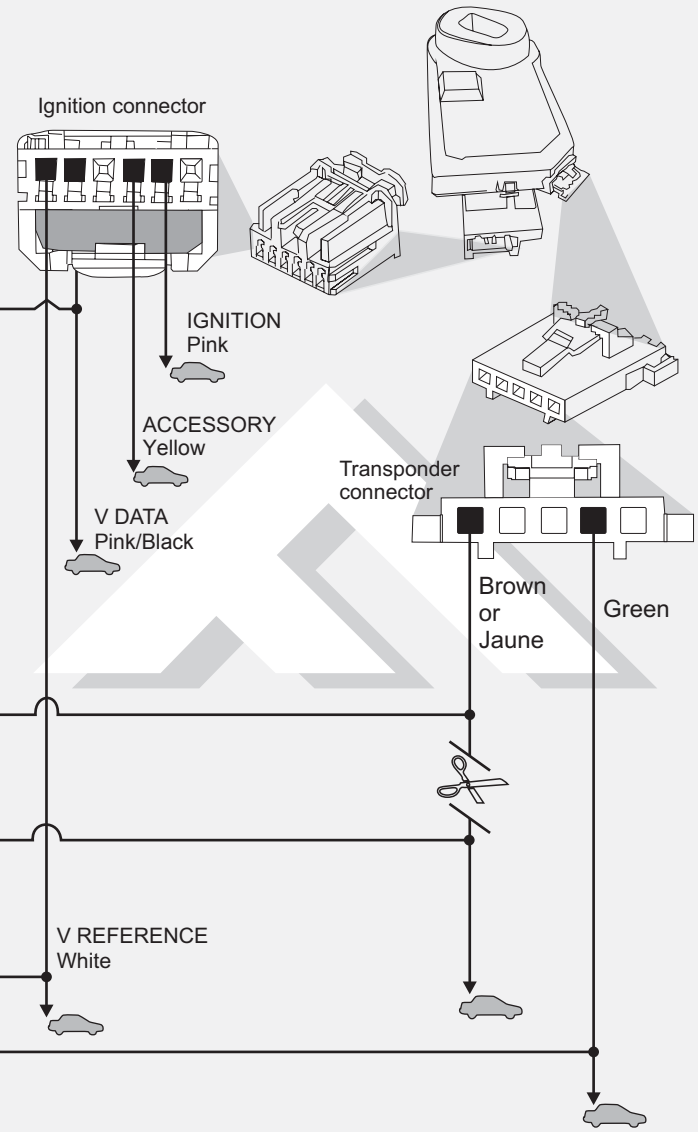

Connect wire to Remote-Starter/Alarm Connect wire to vehicle

○ OUTPUT ● INPUT

Connect: ✓	Branchez: ✓
Lt. Blue	Lt. Blue/Black
White	White/Black
Pink	Pink/Black
Blue	Green
Orange	Orange/Black
Purple	Purple/Black
Yellow	Yellow/Black

Data-Link (1 way)
Brown/White
Grey
Grey/Black
Brown

Connect: ✓	Branchez: ✓
Lt. Blue	Lt. Blue/Black
White	White/Black
Pink	Pink/Black
Blue	Green
Orange	Orange/Black
Purple	Purple/Black
Yellow	Yellow/Black

Data-Link (2 way)
Brown/White
Grey
Grey/Black
Brown

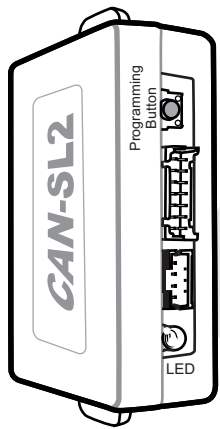

Front view of the module

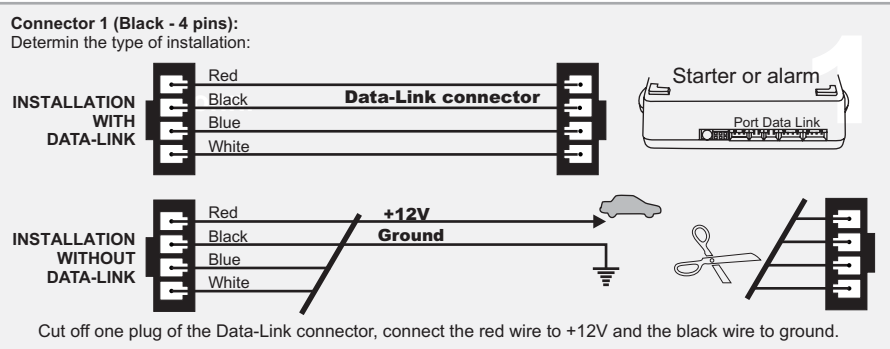

1 **1.A** **Make the connections of the CAN-SL2 to the vehicle:**

Connector 1 (Black):
Determine the type of installation:
INSTALLATION WITH DATA-LINK
INSTALLATION WITHOUT DATA-LINK

1.B **Connector 2 (White):**
Make the connections

1.C **Connector 3 (White, located at the back of the module):**
Make the connections

2 **Press the programming switch while inserting the main wires harness (CONN 1) into the CAN-SL2 module.**
The LED will illuminate to indicate you are in programming mode, release the programming button.

3 **Connect the other connectors (CONN. 2)**
WARNING: Connector 2 can be easily plugged in backwards.

4 **Connect the other connectors (CONN. 3)**

5 Turn the key to the "ON" position.

6 Once the LED starts to flash rapidly turn the key to the **OFF** position.
The LED will turn off to indicate the module has been programmed.
The module is now ready for use.

Connect wire to Remote-Starter/Alarm Connect wire to vehicle

○ OUTPUT ● INPUT

Fonctionnel si équipé

- | | | | |
|---|---|--|--|
| <input type="checkbox"/> Verrouillage | <input type="checkbox"/> Tach | <input type="checkbox"/> Radio Off | <input type="checkbox"/> Sièges chauffants |
| <input type="checkbox"/> Déverrouillage | <input type="checkbox"/> Active Démarreur | <input type="checkbox"/> Transponder Bypass | <input type="checkbox"/> Porte essence |
| <input type="checkbox"/> Armement | <input type="checkbox"/> Status de Porte | <input type="checkbox"/> PK3, Passlock | <input type="checkbox"/> Contrôle fenêtres |
| <input type="checkbox"/> Désarmement | <input type="checkbox"/> Status de Valise | <input type="checkbox"/> Portes Coulissantes | <input type="checkbox"/> Hayon arrière |
| <input type="checkbox"/> Valise | <input type="checkbox"/> Status de Capot | <input type="checkbox"/> Dégivrage | <input type="checkbox"/> Signal de Frein |

ATTENTION: Les fils d'ignition et d'accessoire du démarreur à distance doivent être connectés au barillet d'ignition.

ATTENTION: Chaque fois que le CAN-SL2 est débranché, une fois le module rebranché, démarrez le véhicule avec la clé.

Connexions pour le contournement transpondeur.

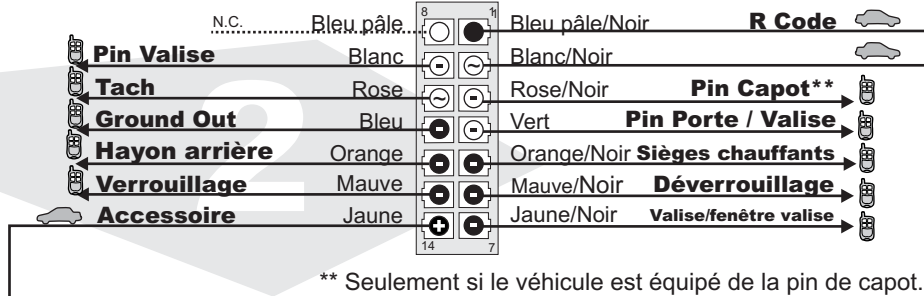
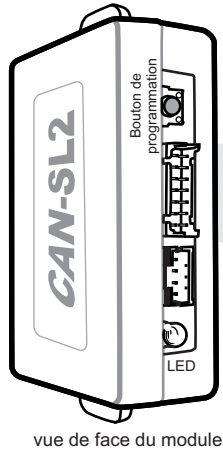

vue de face du module

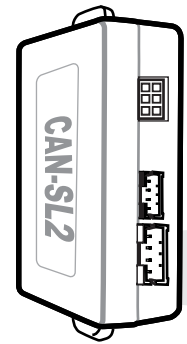

Vue de dos du module

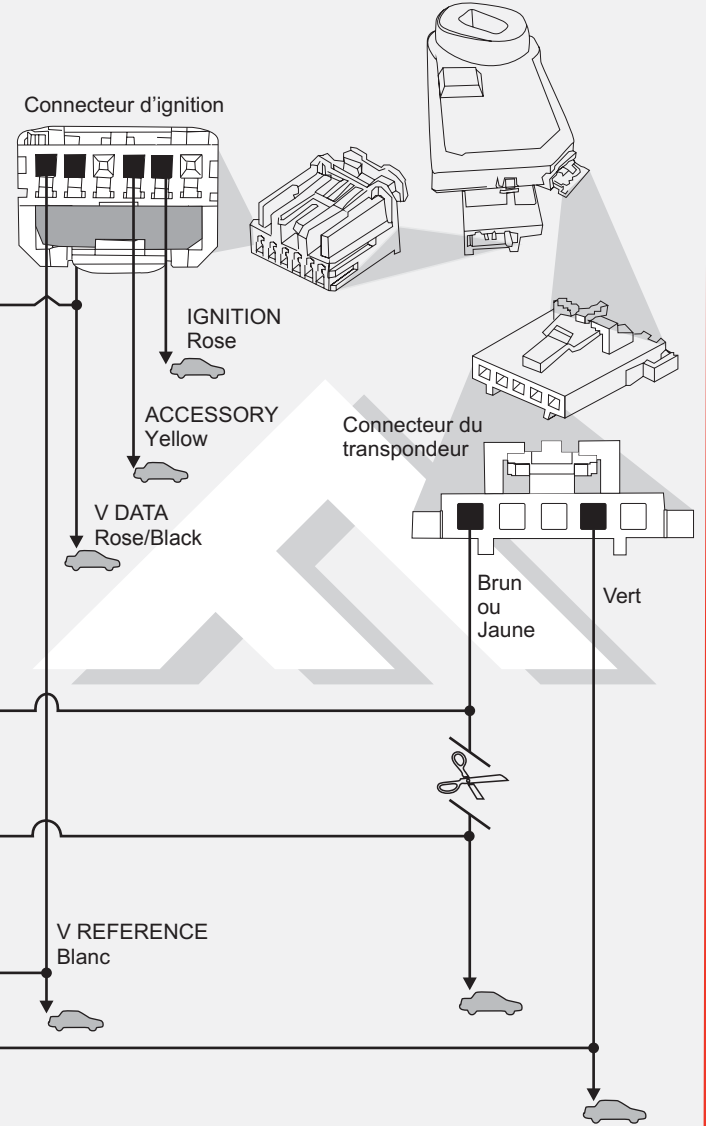

Branchement du filage au démarreur à distance/Alarme Branchement du filage au véhicule ○ SORTIE ● ENTRÉE

<p>Branchez: ✓</p> <table border="0"> <tr><td>Bleu pâle</td><td><input checked="" type="checkbox"/></td><td>Bleu pâle/Noir</td><td><input checked="" type="checkbox"/></td></tr> <tr><td>Blanc</td><td><input checked="" type="checkbox"/></td><td>Blanc/Noir</td><td><input checked="" type="checkbox"/></td></tr> <tr><td>Rose</td><td><input checked="" type="checkbox"/></td><td>Rose/Noir</td><td><input checked="" type="checkbox"/></td></tr> <tr><td>Bleu</td><td><input checked="" type="checkbox"/></td><td>Vert</td><td><input checked="" type="checkbox"/></td></tr> <tr><td>Orange</td><td><input checked="" type="checkbox"/></td><td>Orange/Noir</td><td><input checked="" type="checkbox"/></td></tr> <tr><td>Mauve</td><td><input checked="" type="checkbox"/></td><td>Mauve/Noir</td><td><input checked="" type="checkbox"/></td></tr> <tr><td>Jaune</td><td><input checked="" type="checkbox"/></td><td>Jaune/Noir</td><td><input checked="" type="checkbox"/></td></tr> </table>	Bleu pâle	<input checked="" type="checkbox"/>	Bleu pâle/Noir	<input checked="" type="checkbox"/>	Blanc	<input checked="" type="checkbox"/>	Blanc/Noir	<input checked="" type="checkbox"/>	Rose	<input checked="" type="checkbox"/>	Rose/Noir	<input checked="" type="checkbox"/>	Bleu	<input checked="" type="checkbox"/>	Vert	<input checked="" type="checkbox"/>	Orange	<input checked="" type="checkbox"/>	Orange/Noir	<input checked="" type="checkbox"/>	Mauve	<input checked="" type="checkbox"/>	Mauve/Noir	<input checked="" type="checkbox"/>	Jaune	<input checked="" type="checkbox"/>	Jaune/Noir	<input checked="" type="checkbox"/>	<p>Data-Link (1 way)</p> <p>DL →</p> <table border="0"> <tr><td>Brun/Blanc</td><td><input checked="" type="checkbox"/></td></tr> <tr><td>Gris</td><td><input checked="" type="checkbox"/></td></tr> <tr><td>Gris/Noir</td><td><input checked="" type="checkbox"/></td></tr> <tr><td>Brun</td><td><input checked="" type="checkbox"/></td></tr> </table>	Brun/Blanc	<input checked="" type="checkbox"/>	Gris	<input checked="" type="checkbox"/>	Gris/Noir	<input checked="" type="checkbox"/>	Brun	<input checked="" type="checkbox"/>	<p>Branchez: ✓</p> <table border="0"> <tr><td>Bleu pâle</td><td><input checked="" type="checkbox"/></td><td>Bleu pâle/Noir</td><td><input checked="" type="checkbox"/></td></tr> <tr><td>Blanc</td><td><input checked="" type="checkbox"/></td><td>Blanc/Noir</td><td><input checked="" type="checkbox"/></td></tr> <tr><td>Rose</td><td><input checked="" type="checkbox"/></td><td>Rose/Noir</td><td><input checked="" type="checkbox"/></td></tr> <tr><td>Bleu</td><td><input checked="" type="checkbox"/></td><td>Vert</td><td><input checked="" type="checkbox"/></td></tr> <tr><td>Orange</td><td><input checked="" type="checkbox"/></td><td>Orange/Noir</td><td><input checked="" type="checkbox"/></td></tr> <tr><td>Mauve</td><td><input checked="" type="checkbox"/></td><td>Mauve/Noir</td><td><input checked="" type="checkbox"/></td></tr> <tr><td>Jaune</td><td><input checked="" type="checkbox"/></td><td>Jaune/Noir</td><td><input checked="" type="checkbox"/></td></tr> </table>	Bleu pâle	<input checked="" type="checkbox"/>	Bleu pâle/Noir	<input checked="" type="checkbox"/>	Blanc	<input checked="" type="checkbox"/>	Blanc/Noir	<input checked="" type="checkbox"/>	Rose	<input checked="" type="checkbox"/>	Rose/Noir	<input checked="" type="checkbox"/>	Bleu	<input checked="" type="checkbox"/>	Vert	<input checked="" type="checkbox"/>	Orange	<input checked="" type="checkbox"/>	Orange/Noir	<input checked="" type="checkbox"/>	Mauve	<input checked="" type="checkbox"/>	Mauve/Noir	<input checked="" type="checkbox"/>	Jaune	<input checked="" type="checkbox"/>	Jaune/Noir	<input checked="" type="checkbox"/>	<p>Data-Link (2 way)</p> <p>↔ DL ↔</p> <table border="0"> <tr><td>Brun/Blanc</td><td><input checked="" type="checkbox"/></td></tr> <tr><td>Gris</td><td><input checked="" type="checkbox"/></td></tr> <tr><td>Gris/Noir</td><td><input checked="" type="checkbox"/></td></tr> <tr><td>Brun</td><td><input checked="" type="checkbox"/></td></tr> </table>	Brun/Blanc	<input checked="" type="checkbox"/>	Gris	<input checked="" type="checkbox"/>	Gris/Noir	<input checked="" type="checkbox"/>	Brun	<input checked="" type="checkbox"/>
Bleu pâle	<input checked="" type="checkbox"/>	Bleu pâle/Noir	<input checked="" type="checkbox"/>																																																																								
Blanc	<input checked="" type="checkbox"/>	Blanc/Noir	<input checked="" type="checkbox"/>																																																																								
Rose	<input checked="" type="checkbox"/>	Rose/Noir	<input checked="" type="checkbox"/>																																																																								
Bleu	<input checked="" type="checkbox"/>	Vert	<input checked="" type="checkbox"/>																																																																								
Orange	<input checked="" type="checkbox"/>	Orange/Noir	<input checked="" type="checkbox"/>																																																																								
Mauve	<input checked="" type="checkbox"/>	Mauve/Noir	<input checked="" type="checkbox"/>																																																																								
Jaune	<input checked="" type="checkbox"/>	Jaune/Noir	<input checked="" type="checkbox"/>																																																																								
Brun/Blanc	<input checked="" type="checkbox"/>																																																																										
Gris	<input checked="" type="checkbox"/>																																																																										
Gris/Noir	<input checked="" type="checkbox"/>																																																																										
Brun	<input checked="" type="checkbox"/>																																																																										
Bleu pâle	<input checked="" type="checkbox"/>	Bleu pâle/Noir	<input checked="" type="checkbox"/>																																																																								
Blanc	<input checked="" type="checkbox"/>	Blanc/Noir	<input checked="" type="checkbox"/>																																																																								
Rose	<input checked="" type="checkbox"/>	Rose/Noir	<input checked="" type="checkbox"/>																																																																								
Bleu	<input checked="" type="checkbox"/>	Vert	<input checked="" type="checkbox"/>																																																																								
Orange	<input checked="" type="checkbox"/>	Orange/Noir	<input checked="" type="checkbox"/>																																																																								
Mauve	<input checked="" type="checkbox"/>	Mauve/Noir	<input checked="" type="checkbox"/>																																																																								
Jaune	<input checked="" type="checkbox"/>	Jaune/Noir	<input checked="" type="checkbox"/>																																																																								
Brun/Blanc	<input checked="" type="checkbox"/>																																																																										
Gris	<input checked="" type="checkbox"/>																																																																										
Gris/Noir	<input checked="" type="checkbox"/>																																																																										
Brun	<input checked="" type="checkbox"/>																																																																										

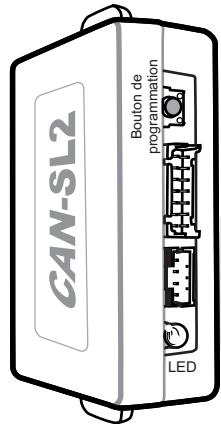

vue de face du module

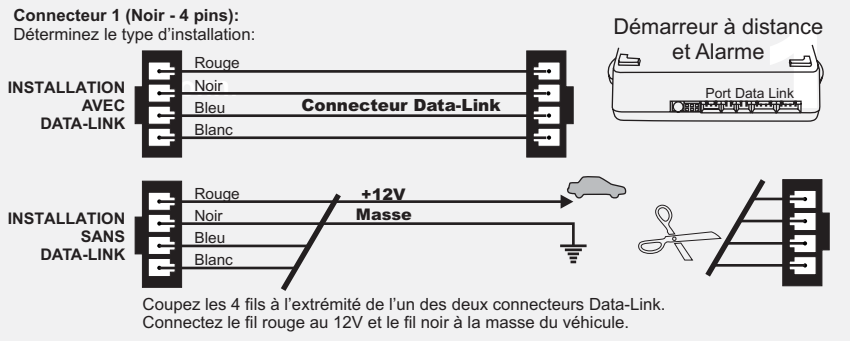

1 **1.A** **Connecteur 1 (Noir):**
Déterminez le type d'installation (**Data-Link** ou **non Data-Link**)
Pour l'installation DATA-LINK assurez vous de la présence du connecteur DATA-LINK sur le démarreur.
Pour installation non Data-Link voir INSTALLATION SANS DATA-LINK.

1.B **Connecteur 2 (Blanc):**
Effectuez les branchements

1.C **Connecteur 3 (Blanc, situé au dos du module):**
Effectuez les branchements

2 **Maintenez le bouton de programmation enfoncé** en insérant le **connecteur 1** dans le CAN-SL2.
Le DEL s'allume pour indiquer le début de la programmation, **relâchez le bouton de programmation.**

3 Branchez le connecteur 2 (**CONN. 2**)
ATTENTION: Ne pas brancher le connecteur à l'envers.

4 Branchez le connecteur 3 (**CONN. 3**)

5 Tournez la clef en position **ignition**.

6 Lorsque le DEL clignote rapidement, **tournez la clef en position OFF.**
Le DEL s'éteint pour indiquer que le module est programmé.

Branchement du filage au démarreur à distance/Alarme Branchement du filage au véhicule ○ SORTIE ● ENTRÉE