



# LAND ROVER LR2 Freelander 2007-2009



**CAN-SL2**  
Made in Canada Rev. A - 14 / 01 / 2009  
Web site: <http://www.ifar.ca>

## ALARM AND REMOTE STARTER CAN BUS INTERFACE KIT

### Fonctionnal if equipped

- |  |   |   |   |
|--|---|---|---|
| <input checked="" type="checkbox"/> Lock   | <input checked="" type="checkbox"/> Tach          | <input type="checkbox"/> Radio Off          | <input type="checkbox"/> Heat Seats       |
| <input checked="" type="checkbox"/> Unlock | <input type="checkbox"/> Start Enable             | <input type="checkbox"/> Transponder Bypass | <input type="checkbox"/> Gas Door         |
| <input type="checkbox"/> Arm               | <input checked="" type="checkbox"/> Door Trigger  | <input type="checkbox"/> PK3, Passlock      | <input type="checkbox"/> Window Roll Down |
| <input type="checkbox"/> Disarm            | <input checked="" type="checkbox"/> Trunk Trigger | <input type="checkbox"/> Slidding Door      | <input type="checkbox"/> Hatch            |
| <input checked="" type="checkbox"/> Trunk  | <input checked="" type="checkbox"/> Hood Trigger  | <input type="checkbox"/> Defrost            | <input type="checkbox"/> Brake Signal     |

For remote car starter see: **INT-LRV**

Connect: <input checked="" type="checkbox"/>	Branchez: <input checked="" type="checkbox"/>
Lt. Blue <input checked="" type="checkbox"/>	Lt. Blue/Black <input checked="" type="checkbox"/>
White <input checked="" type="checkbox"/>	White/Black <input checked="" type="checkbox"/>
Pink <input checked="" type="checkbox"/>	Pink/Black <input checked="" type="checkbox"/>
Blue <input checked="" type="checkbox"/>	Green <input checked="" type="checkbox"/>
Orange <input checked="" type="checkbox"/>	Orange/Black <input checked="" type="checkbox"/>
Purple <input checked="" type="checkbox"/>	Purple/Black <input checked="" type="checkbox"/>
Yellow <input checked="" type="checkbox"/>	Yellow/Black <input checked="" type="checkbox"/>

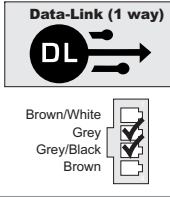

Connect: <input checked="" type="checkbox"/>	Branchez: <input checked="" type="checkbox"/>
Lt. Blue <input type="checkbox"/>	Lt. Blue/Black <input type="checkbox"/>
White <input type="checkbox"/>	White/Black <input type="checkbox"/>
Pink <input type="checkbox"/>	Pink/Black <input type="checkbox"/>
Blue <input type="checkbox"/>	Green <input type="checkbox"/>
Orange <input type="checkbox"/>	Orange/Black <input type="checkbox"/>
Purple <input type="checkbox"/>	Purple/Black <input type="checkbox"/>
Yellow <input type="checkbox"/>	Yellow/Black <input type="checkbox"/>

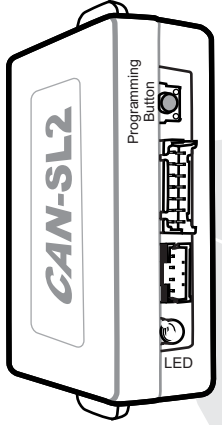
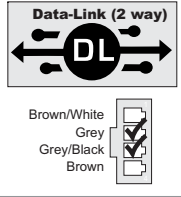

Front of the module

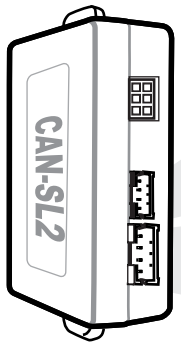
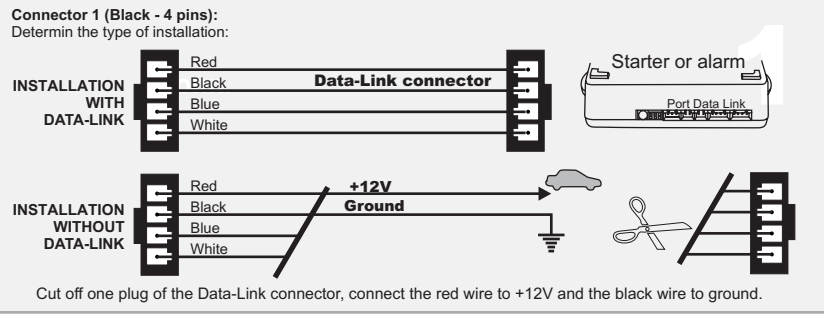
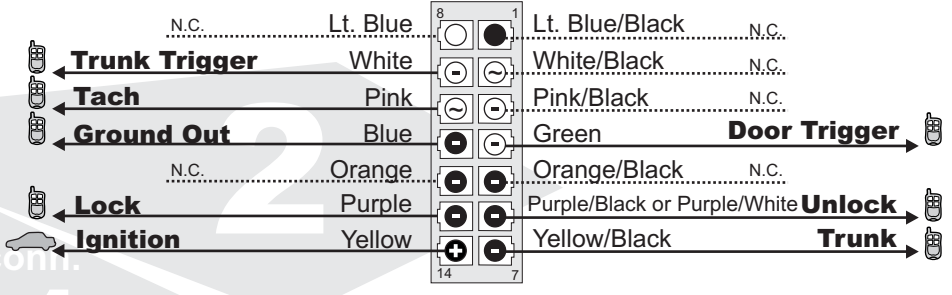

Back of the module

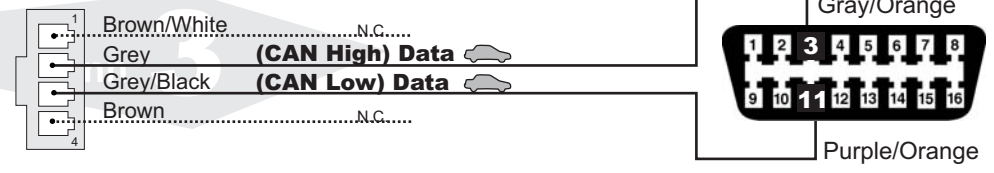
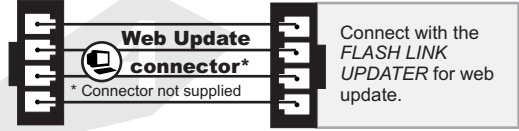

Connect wire to Remote-Starter/Alarm Connect wire to vehicle ○ OUTPUT ● INPUT

- 1.1.A** Connector 1 (Black):  
Determine the type of installation:  
INSTALLATION WITH DATA-LINK  
INSTALLATION WITHOUT DATA-LINK
- 1.B** Connector 2 (White):  
Make the connections
- 1.C** Connector 3 (White, located at the back of the module):  
Make the connections
- 2** Press the programming switch while inserting the main wires harness (CONN 1) into the CAN-SL2 module. The LED will illuminate to indicate you are in programming mode, release the programming button.
- 3** Connect the other connectors (CONN. 2)  
**WARNING: Connector 2 can be easily plugged in backwards.**
- 4** Connect the other connectors (CONN. 3)
- 5** Turn the key to the "ON" position.
- 6** Once the LED starts to flash rapidly turn the key to the OFF position.  
The LED will turn off to indicate the module has been programmed.  
**The module is now ready for use.**



**Technical support:**  
TEL: 514-255-HELP (4357)  
FAX: 514-255-1367  
Web: [www.ifar.ca](http://www.ifar.ca)

Neither the manufacturer or distributor of this module is responsible of damages of any kind indirectly or directly caused by this module, except for the replacement of this module in case of manufacturing defects. This module must be install by qualified technician. This instruction guide may change without notice. Visit [www.ifar.ca](http://www.ifar.ca) to get latest version.



# LAND ROVER LR2 Freelander 2007-2009

MISE À JOUR PAR INTERNET

**CAN-SL2**  
Fabriqué au Canada Rev. A - 14 / 01 / 2009  
Site internet <http://www.ifar.ca>

MODULE D'INTERFACE CAN BUS POUR ALARME ET DÉMARREUR À DISTANCE

## Fonctionnel si équipé

- |  |  |  |  |
|--|--|--|--|
| <input checked="" type="checkbox"/> Verrouillage   | <input checked="" type="checkbox"/> Tach             | <input type="checkbox"/> Radio Off           | <input type="checkbox"/> Sièges chauffants |
| <input checked="" type="checkbox"/> Déverrouillage | <input checked="" type="checkbox"/> Active Démarreur | <input type="checkbox"/> Transponder Bypass  | <input type="checkbox"/> Porte essence     |
| <input type="checkbox"/> Armement                  | <input checked="" type="checkbox"/> Status de Porte  | <input type="checkbox"/> PK3, Passlock       | <input type="checkbox"/> Contrôle portes   |
| <input type="checkbox"/> Désarmement               | <input checked="" type="checkbox"/> Status de Valise | <input type="checkbox"/> Portes Coulissantes | <input type="checkbox"/> Hayon arrière     |
| <input checked="" type="checkbox"/> Valise         | <input checked="" type="checkbox"/> Status de Capot  | <input type="checkbox"/> Dégivrage           | <input type="checkbox"/> Signal de Frein   |

Pour installation d'un démarreur à distance voir: INT-LRV

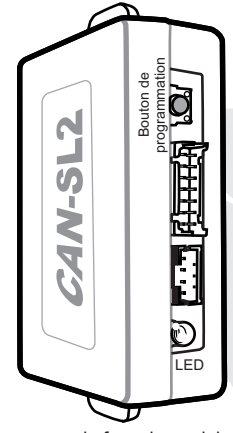

vue de face du module

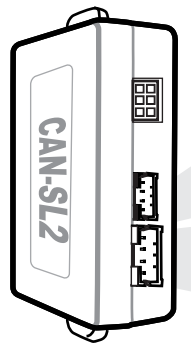
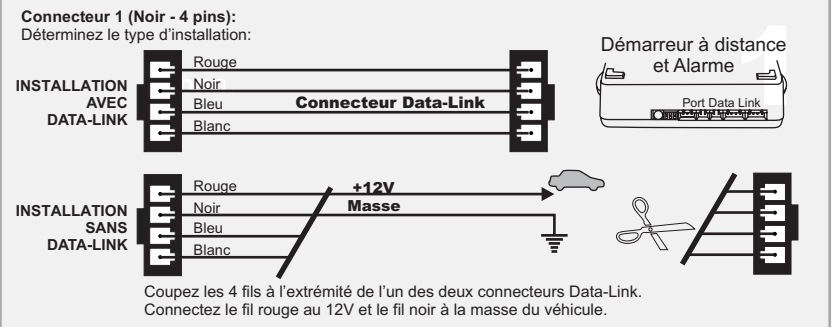
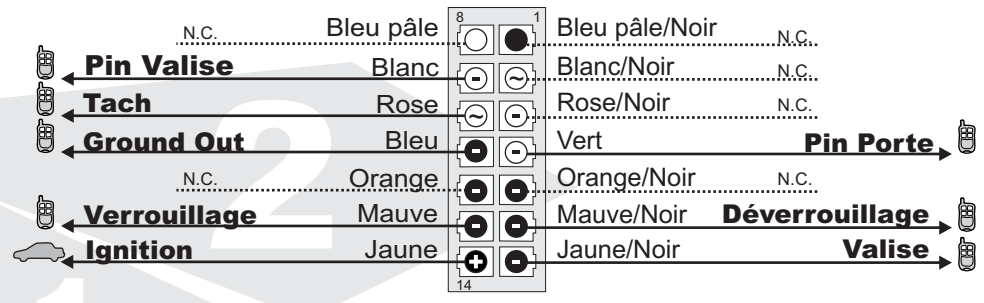

Vue de dos du module

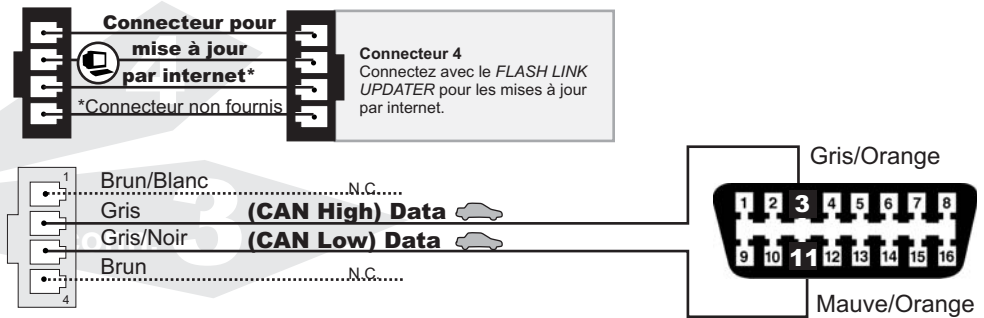

Branchement du filage au démarreur à distance/Alarme Branchement du filage au véhicule ○ SORTIE ● ENTRÉE

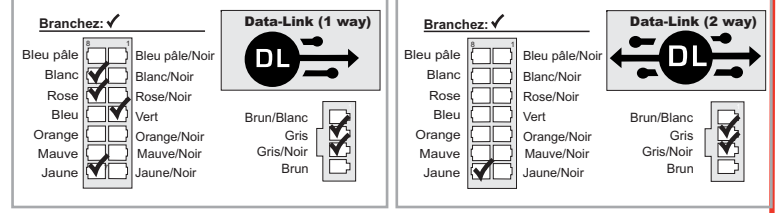

- 1** **1.A** **Connecteur 1 (Noir):**  
Déterminez le type d'installation (Data-Link ou non Data-Link) Pour l'installation DATA-LINK assurez vous de la présence du connecteur DATA-LINK sur le démarreur.. Pour installation non Data-Link voir INSTALLATION SANS DATA-LINK.
- 1.B** **Connecteur 2 (Blanc):**  
Effectuez les branchements
- 1.C** **Connecteur 3 (Blanc, situé au dos du module):**  
Effectuez les branchements
- 2** **Maintenez le bouton de programmation enfoncé** en insérant le **connecteur 1** dans le CAN-SL2. Le DEL s'allume pour indiquer le début de la programmation, **relâchez le bouton de programmation.**
- 3** Branchez le connecteur 2 (**CONN. 2**)  
**ATTENTION: Ne pas brancher le connecteur à l'envers.**
- 4** Branchez le connecteur 3 (**CONN. 3**)
- 5** Tournez la clef en position **ignition.**
- 6** Lorsque le DEL clignote rapidement, **tournez la clef en position OFF.**  
**Le DEL s'éteint pour indiquer que le module est programmé.**



Support Technique:  
TEL: 514-255-HELP (4357)  
FAX: 514-255-1367  
Site internet: [www.ifar.ca](http://www.ifar.ca)

Ni le manufacturier, ni le distributeur ne se considèrent responsables des dommages causés ou ayant pu être causés, indirectement ou directement, par ce module, excepté le remplacement de ce module en cas de défectuosité de fabrication. Ce module doit être installé par un technicien qualifié. Ce guide d'instruction peut faire l'objet de changement sans préavis. Consultez le [www.ifar.ca](http://www.ifar.ca) pour voir la plus récente version.