











1  **Make the connections of the INT-SL to the vehicle:**

1.A  **Connector 1 (Black):**
Determine the type of installation:
INSTALLATION WITH DATA-LINK
INSTALLATION WITHOUT DATA-LINK

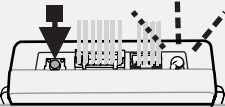
1.B  **Connector 2 (White):**
Make the connections

- 2**  Press and hold the programming button. Plug in the **connector 1** in the INT-SL interface.
- 3**  The LED will turn on, indicating the beginning of programming.
- 4**  Plug the **connector 2** into the INT-SL interface.
WARNING: Connector 2 can be easily plugged in backwards.
- 5**  While holding the programming button, turn the key to the ignition position.
- 6**  The LED will flash rapidly.
- 7**  Release the programming button.
- 8**  Start the vehicle with the key.
- 9**  The LED will turn off.
- 10**  Turn the key OFF.
The interface is programmed.

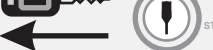
FONCTIONNAL IF EQUIPPED

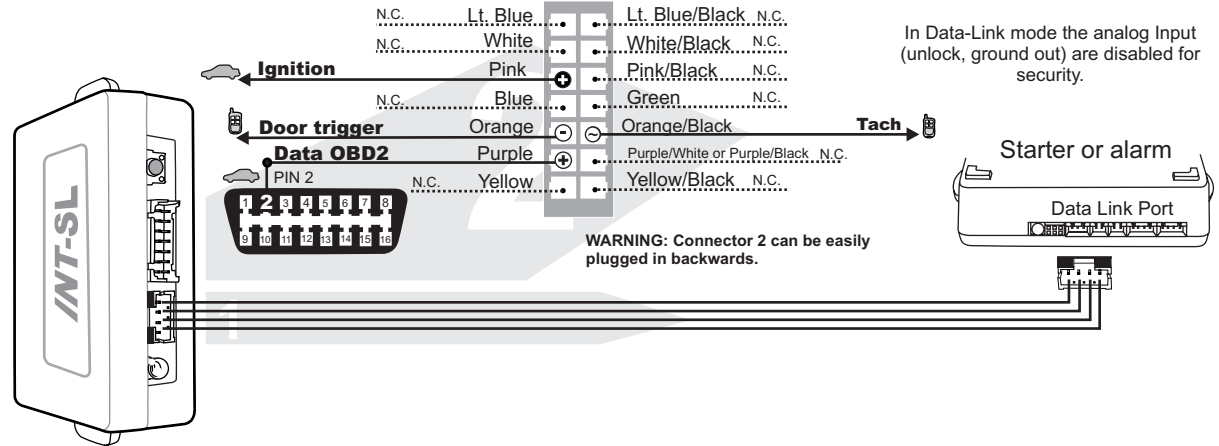

- | | | | |
|------------------------------------------------------------------|------------------------------------------------------------------------------------------------------------------------------------------------------------------------------|---------------------------------------------------------------------------------|-----------------------------------------------------------------|
| <input checked="" type="checkbox"/> Bypass PK3, Passlock or VATS | <input checked="" type="checkbox"/> Heated Seats and Heated Mirrors (Heated seats will turn ON (low power) ONLY if the engine temp is below 0°C (32°F) when remote started.) | <input checked="" type="checkbox"/> Rear Defrost | <input type="checkbox"/> Start |
| <input checked="" type="checkbox"/> Doorlock Control | | <input checked="" type="checkbox"/> Parking Light Control | <input type="checkbox"/> Sliding doors |
| <input checked="" type="checkbox"/> Factory Alarm Control (OEM) | | <input checked="" type="checkbox"/> Retained Accessory Power | <input checked="" type="checkbox"/> Tach |
| <input type="checkbox"/> Trunk Release | | <input checked="" type="checkbox"/> Memory selection Driver 1 and 2 (by Unlock) | <input checked="" type="checkbox"/> Hand Brake Data-Link |
| <input checked="" type="checkbox"/> Door status | | | <input checked="" type="checkbox"/> Foot Brake Data-Link |

WITH DATA-LINK

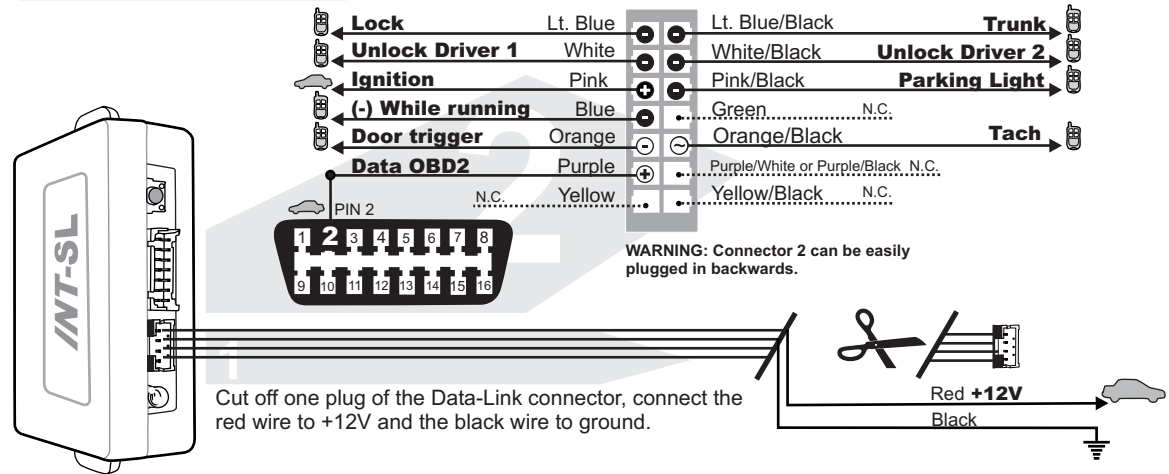

WITHOUT DATA-LINK



 Connect wire to Remote-Starter/Alarm  Connect wire to vehicle ○ OUTPUT ● INPUT



1 Effectuez les connexions du INT-SL Au véhicule:

1.A **Connecteur 1 (Noir):**
Déterminez le type d'installation:
AVEC Data-Link ou SANS Data-Link
(Pour l'installation AVEC Data-Link assurez vous de la présence du connecteur Data-Link sur le démarreur.)

1.B **Connecteur 2 (Blanc):**
Effectuez les branchements

2 Maintenez le bouton de programmation enfoncé. Branchez le **connecteur 1** dans le module INT-SL.

3 Le DEL s'allume pour indiquer le début de la programmation.

4 Branchez le **connecteur 2** dans le module INT-SL.

ATTENTION: Ne pas brancher à l'envers.

5 Ne pas relâcher le bouton de programmation et tourner la clef en position ignition.

6 Le DEL clignote rapidement.

7 Relâchez le bouton de programmation.

8 Démarrez le véhicule avec la clef.

9 Le DEL s'éteint.

10 Tournez la clef à OFF.
Le module est programmé.

FONCTIONNEL SI ÉQUIPÉ

- | | | | |
|-------------------------------------------------------------------------------|-------------------------------------------------------------------------------------------------------------------------------------------------------------------|--------------------------------------------------------------------------------------------------|-----------------------------------------------------------------------------|
| <input checked="" type="checkbox"/> Contournement PK3, Passlock, VATS | <input checked="" type="checkbox"/> Sièges et rétroviseurs chauffants | <input checked="" type="checkbox"/> Dégivreur arrière | <input type="checkbox"/> Démarrage |
| <input checked="" type="checkbox"/> Verrouillage et déverrouillage des portes | <input checked="" type="checkbox"/> (Les sièges chauffants s'allument à faible intensité SEULEMENT si la température du moteur est sous 0°C (32°F) au démarrage.) | <input checked="" type="checkbox"/> Contrôle des feux de stationnement | <input type="checkbox"/> Portes coulissantes |
| <input checked="" type="checkbox"/> Contrôle d'Alarme d'origine (OEM) | | <input checked="" type="checkbox"/> Radio RAP accessoires | <input checked="" type="checkbox"/> Tach |
| <input type="checkbox"/> Valise | | <input checked="" type="checkbox"/> Sélection de mémoires conducteur 1 et 2 (par déverrouillage) | <input checked="" type="checkbox"/> Signal Frein à main Data-Link |
| <input checked="" type="checkbox"/> Status des portes | | | <input checked="" type="checkbox"/> Signal Pédale de frein Data-Link |

AVEC DATA-LINK

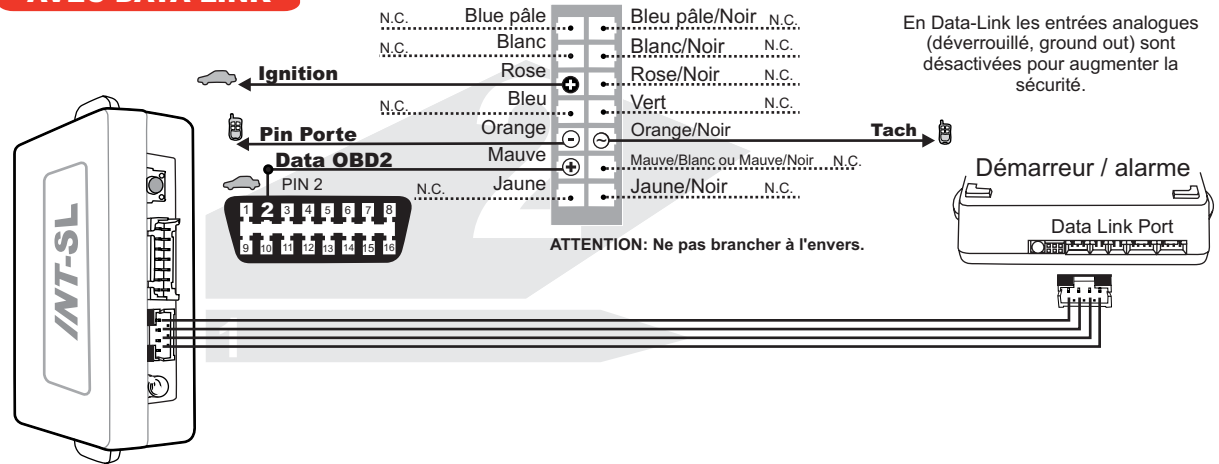

SANS DATA-LINK

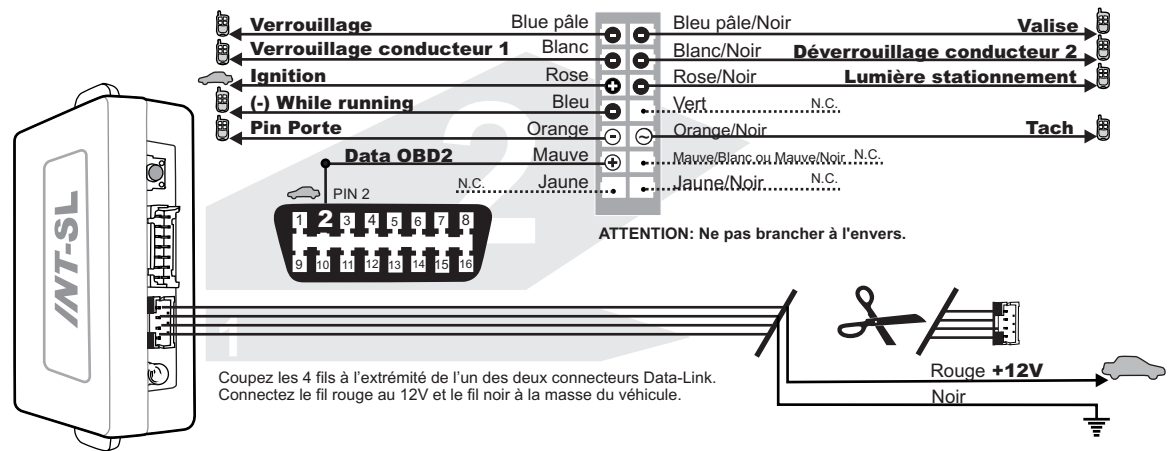

Branchement du filage au démarreur à distance/Alarme Branchement du filage au véhicule ○ SORTIE ● ENTRÉE