

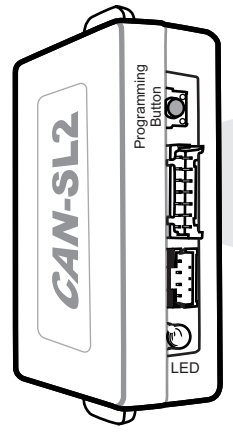

ALARM AND REMOTE STARTER CAN BUS INTERFACE KIT

Fonctionnal if equipped

- | | | | |
|---------------------------------|--|---|---|
| <input type="checkbox"/> Lock | <input type="checkbox"/> Tach | <input type="checkbox"/> Radio Off | <input type="checkbox"/> Heat Seats |
| <input type="checkbox"/> Unlock | <input type="checkbox"/> Start Enable | <input type="checkbox"/> Transponder Bypass | <input type="checkbox"/> Gas Door |
| <input type="checkbox"/> Arm | <input type="checkbox"/> Door Trigger | <input type="checkbox"/> PK3, Passlock | <input type="checkbox"/> Window Roll Down |
| <input type="checkbox"/> Disarm | <input type="checkbox"/> Trunk Trigger | <input type="checkbox"/> Sliding Door | <input type="checkbox"/> Hatch |
| <input type="checkbox"/> Trunk | <input type="checkbox"/> Hood Trigger | <input type="checkbox"/> Defrost | <input type="checkbox"/> Brake Signal |



Front view of the module

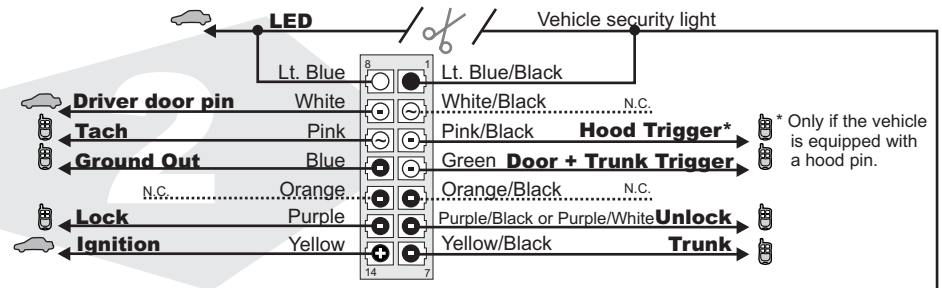

To control de OEM Alarm on vehicle (NON INTELLI-KEY vehicles) add the following wires to the empty pins on the BCM.



Front view of the BCM connector located on the driver kick panel or above the acceleration pedal.

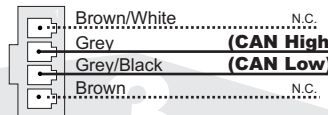
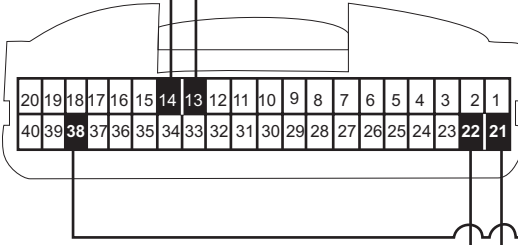

conn. 3

OR / OU

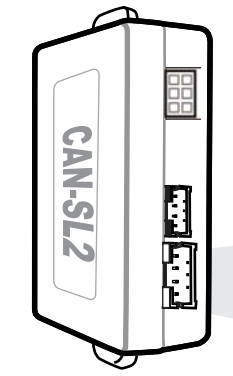
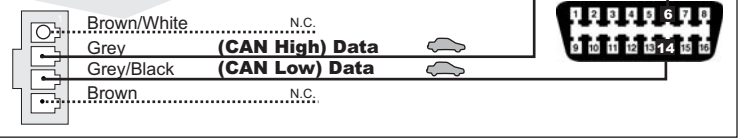

Back view of the module

Connect wire to Remote-Starter/Alarm Connect wire to vehicle ○ OUTPUT ● INPUT

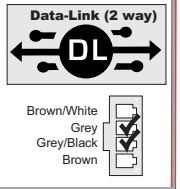
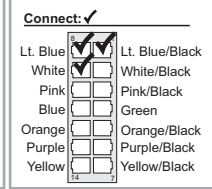
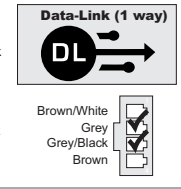
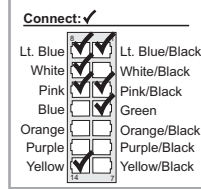

- 1** **1.A** **Connector 1 (Black):**
 Determine the type of installation:
 INSTALLATION WITH DATA-LINK (see page 2)
 INSTALLATION WITHOUT DATA-LINK (see page 2)
- 1.B** **Connector 2 (White):**
 Make the connections
- 1.C** **Connector 3 (White, located at the back of the module):**
 Make the connections
- 2** **Press the programming switch** while inserting the main wires harness (**CONN 1**) into the CAN-SL2 module. The LED will illuminate to indicate you are in programming mode, release the programming button.
- 3** **Connect the other connectors (CONN. 2)**
WARNING: Connector 2 can be easily plugged in backwards.
- 4** **Connect the other connectors (CONN. 3)**
- 5** Turn the key to the "ON" position.
- 6** Once the LED starts to flash rapidly turn the key to the **OFF** position.
 The LED will turn off to indicate the module has been programmed.
The module is now ready for use.



Technical support:
 TEL: 514-255-HELP (4357)
 FAX: 514-255-1367
 Web: www.ifar.ca

Neither the manufacturer or distributor of this module is responsible of damages of any kind indirectly or directly caused by this module, except for the replacement of this module in case of manufacturing defects. This module must be install by qualified technician. This instruction guide may change without notice. Visit www.ifar.ca to get latest version.

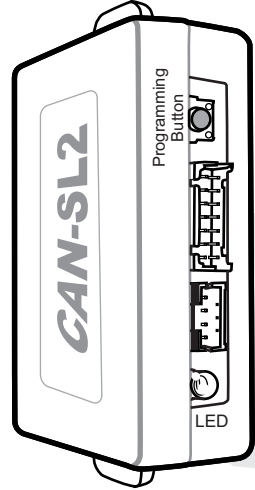

Front of the module

conn.
1

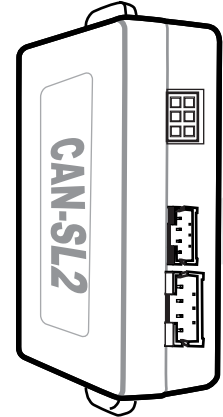
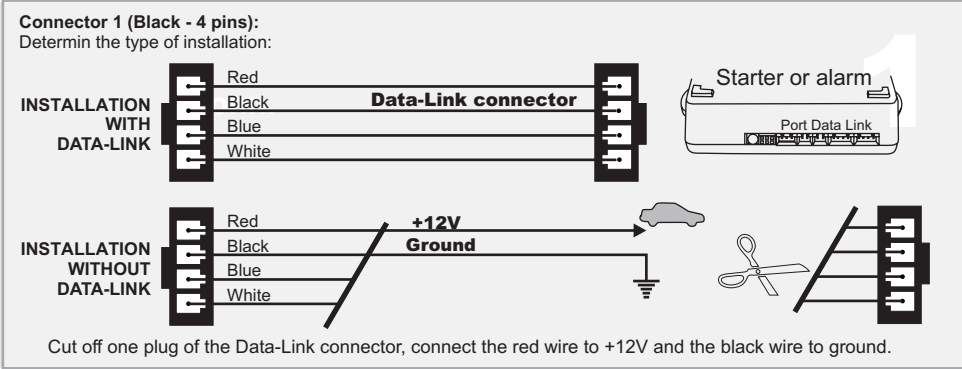

Back of the module

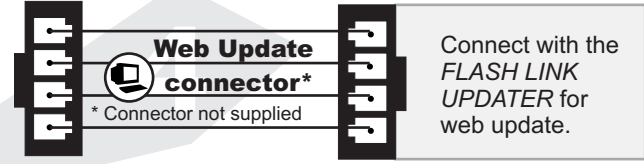

Connect wire to Remote-Starter/Alarm Connect wire to vehicle OUTPUT INPUT



Technical support:
 TEL: 514-255-HELP (4357)
 FAX: 514-255-1367
 Web: www.ifar.ca

Neither the manufacturer or distributor of this module is responsible of damages of any kind indirectly or directly caused by this module, except for the replacement of this module in case of manufacturing defects. This module must be install by qualified technician. This instruction guide may change without notice. Visit www.ifar.ca to get latest version.



MISE À JOUR PAR INTERNET

CAN-SL2 Fabriqu  au Canada Rev. A - 14 / 01 / 2009 Site internet http://www.ifar.ca

MODULE D'INTERFACE CAN BUS POUR ALARME ET D MARREUR   DISTANCE

Fonctionnel si  quipp 

- Verrouillage
- D verrouillage
- Armement
- D sarmement
- Valise
- Tach
- Active D marreur
- Statut de Porte
- Statut de Valise
- Statut de Capot
- Radio Off
- Transponder Bypass
- PK3, Passlock
- Portes Couissantes
- D givrage
- Si ges chauffants
- Porte essence
- Contr le fen tres
- Hayon arri re
- Signal de Frein

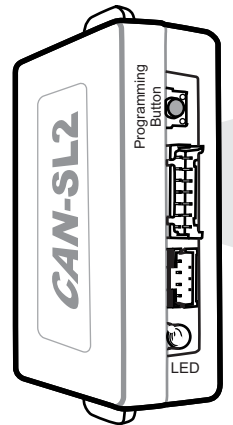

Vue de face du module

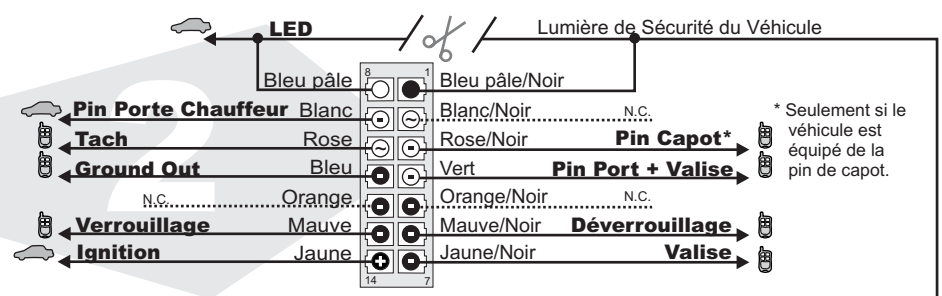

Pour contr ler l'alarme d'origine des v hicules **NON  QUIP S DE L'INTELLI-KEY** ajoutez des fils dans les espaces vides du BCM.

D verrouillage

Verrouillage

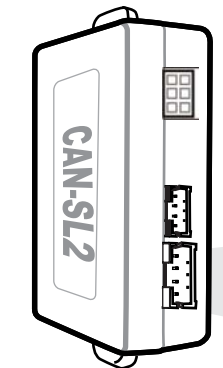
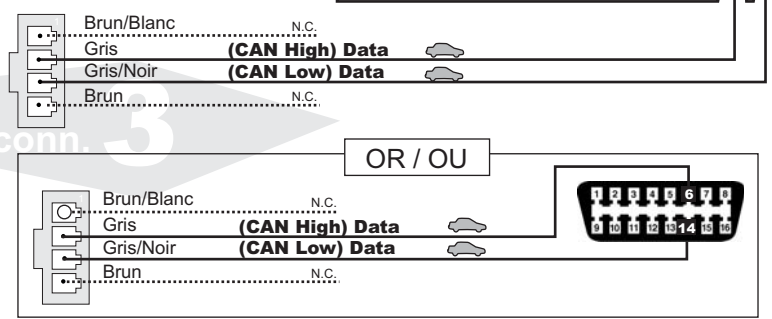
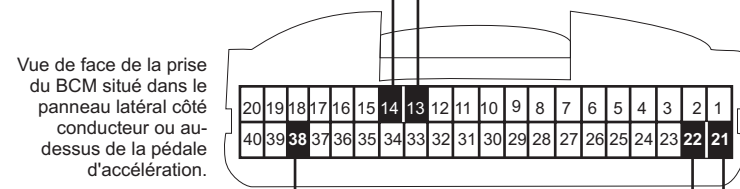

Vue de dos du module

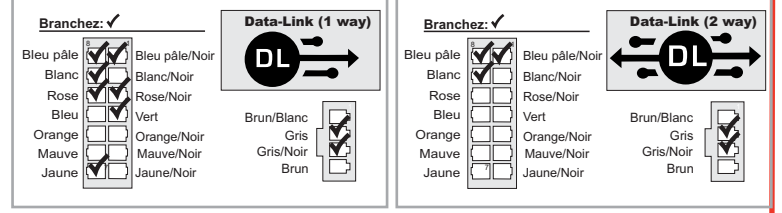

Effectuez les connexions du CAN-SL2 au v hicule:

- 1 1.A** **Connecteur 1 (Noir):**
D terminez le type d'installation (Data-Link ou non Data-Link) Pour l'installation DATA-LINK assurez vous de la pr sence du connecteur DATA-LINK sur le d marreur. Voir page 2 Pour installation non Data-Link voir INSTALLATION SANS DATA-LINK. Voir page 2
- 1.B** **Connecteur 2 (Blanc):**
Effectuez les branchements
- 1.C** **Connecteur 3 (Blanc, situ  au dos du module):**
Effectuez les branchements

2 **Maintenez le bouton de programmation enfonc ** en ins rant le **connecteur 1** dans le CAN-SL2. Le DEL s'allume pour indiquer le d but de la programmation, **rel chez le bouton de programmation.**

3 Branchez le connecteur 2 (**CONN. 2**)

ATTENTION: Ne pas brancher le connecteur   l'envers.

4 Branchez le connecteur 3 (**CONN. 3**)

5 Tournez la clef en position **ignition.**

6 Lorsque le DEL clignote rapidement, **tournez la clef en position OFF.**

Le DEL s' teint pour indiquer que le module est programm .

Branchement du filage au d marreur   distance/Alarme Branchement du filage au v hicule SORTIE ENTR E



Support Technique:
TEL: 514-255-HELP (4357)
FAX: 514-255-1367
Site internet: www.ifar.ca

Ni le manufacturier, ni le distributeur ne se consid rent responsables des dommages caus s ou ayant pu  tre caus s, indirectement ou directement, par ce module, except  le remplacement de ce module en cas de d fectuosit  de fabrication. Ce module doit  tre install  par un technicien qualifi . Ce guide d'instruction peut faire l'objet de changement sans pr avis. Consultez le www.ifar.ca pour voir la plus r cente version.



MISE À JOUR
PAR INTERNET

CAN-SL2

Fabriqué au Canada Rev. A - 14 / 01 / 2009
Site internet <http://www.ifar.ca>

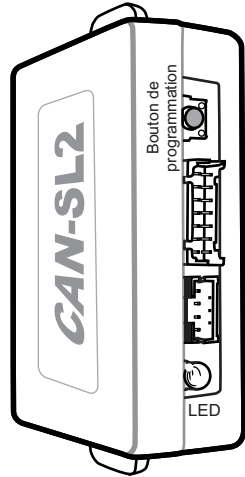

vue de face du module

Connecteur 1 (Noir - 4 pins):
Déterminez le type d'installation:

**INSTALLATION
AVEC
DATA-LINK**

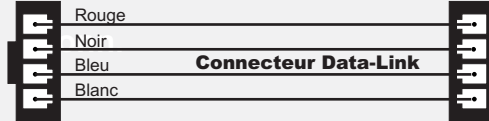

Démarrreur à distance
et Alarme



**INSTALLATION
SANS
DATA-LINK**

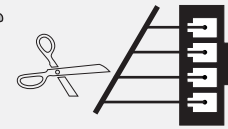
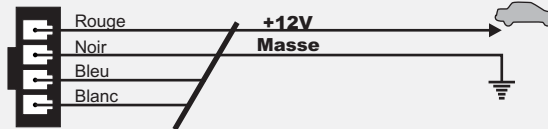

Coupez les 4 fils à l'extrémité de l'un des deux connecteurs Data-Link.
Connectez le fil rouge au 12V et le fil noir à la masse du véhicule.

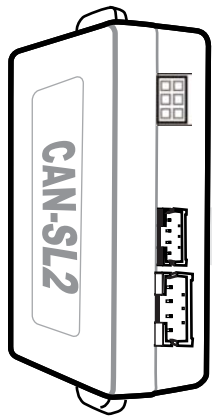

vue de dos du module

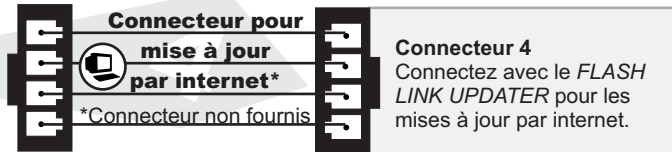

Connecteur 4
Connectez avec le *FLASH LINK UPDATER* pour les mises à jour par internet.

Branchement du filage au démarreur à distance/Alarme Branchement du filage au véhicule ○ SORTIE ● ENTRÉE



Support Technique:
TEL: 514-255-HELP (4357)
FAX: 514-255-1367
Site internet: www.ifar.ca

Ni le fabricant, ni le distributeur ne se considèrent responsables des dommages causés ou ayant pu être causés, indirectement ou directement, par ce module, excepté le remplacement de ce module en cas de défectuosité de fabrication. Ce module doit être installé par un technicien qualifié. Ce guide d'instruction peut faire l'objet de changement sans préavis. Consultez le www.ifar.ca pour voir la plus récente version.