



# VOLKSWAGEN Passat

## 2006-2008



# CAN-SL2

Made in Canada Rev. B - 09 / 02 / 2009  
Web site: <http://www.ifar.ca>

### ALARM AND REMOTE STARTER CAN BUS INTERFACE KIT

#### Fonctionnal if equipped

- |  |   |   |  |
|--|---|---|--|
| <input checked="" type="checkbox"/> Lock   | <input checked="" type="checkbox"/> Tach          | <input type="checkbox"/> Radio Off          | <input type="checkbox"/> Heat Seats          |
| <input checked="" type="checkbox"/> Unlock | <input type="checkbox"/> Start Enable             | <input type="checkbox"/> Transponder Bypass | <input checked="" type="checkbox"/> Gas Door |
| <input checked="" type="checkbox"/> Arm    | <input checked="" type="checkbox"/> Door Trigger  | <input type="checkbox"/> PK3, Passlock      | <input type="checkbox"/> Window Roll Down    |
| <input type="checkbox"/> Disarm            | <input checked="" type="checkbox"/> Trunk Trigger | <input type="checkbox"/> Sliding Door       | <input type="checkbox"/> Hatch               |
| <input type="checkbox"/> Trunk             | <input checked="" type="checkbox"/> Hood Trigger  | <input type="checkbox"/> Defrost            | <input type="checkbox"/> Brake Signal        |

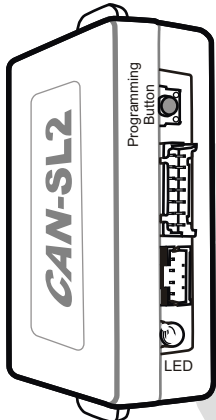

Front of the module

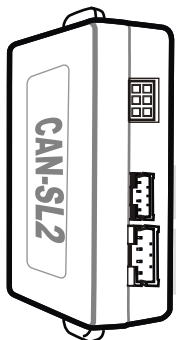
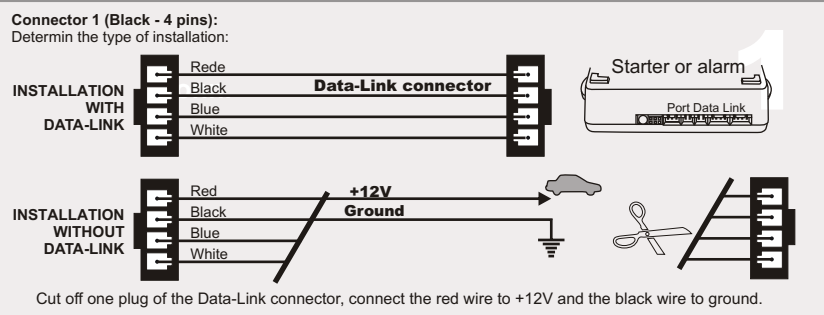
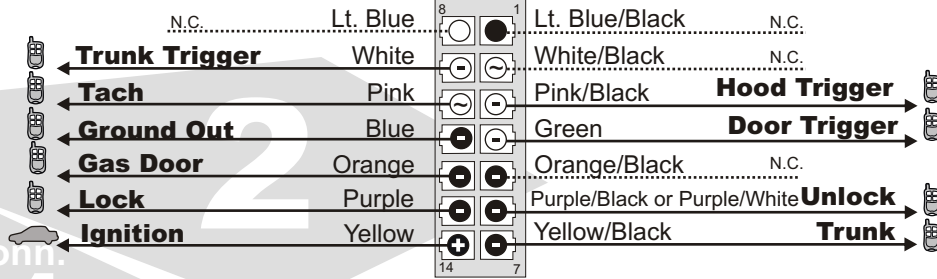

Back of the module

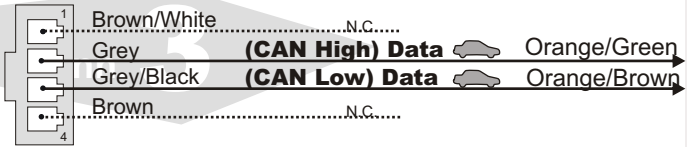
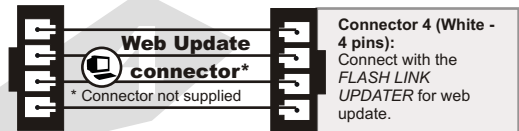

Connect wire to Remote-Starter/Alarm    Connect wire to vehicle    ○ OUTPUT    ● INPUT

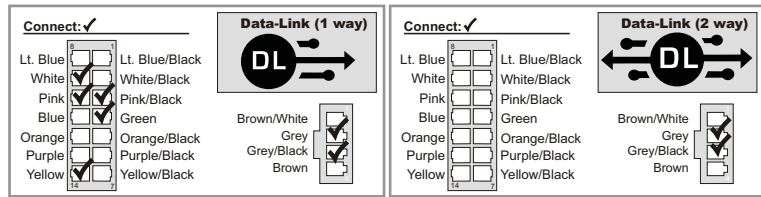

- 1.1** **1.A** **Connector 1 (Black):**  
Determine the type of installation:  
INSTALLATION WITH DATA-LINK  
INSTALLATION WITHOUT DATA-LINK
- 1.1** **1.B** **Connector 2 (White):**  
Make the connections
- 1.1** **1.C** **Connector 3 (White, located at the back of the module):**  
Make the connections
- 2** **Press** the programming switch while inserting the main wires harness (**CONN 1**) into the CAN-SL2 module. The LED will illuminate to indicate you are in programming mode, release the programming button.
- 3** **Connect** the other connectors (**CONN. 2**)  
**WARNING: Connector 2 can be easily plugged in backwards.**
- 4** **Connect** the other connectors (**CONN. 3**)
- 5** Turn the key to the "ON" position.
- 6** Once the LED starts to flash rapidly turn the key to the **OFF** position.  
The LED will turn off to indicate the module has been programmed.  
**The module is now ready for use.**



**Technical support:**  
TEL: 514-255-HELP (4357)  
FAX: 514-255-1367  
Web: [www.ifar.ca](http://www.ifar.ca)

Neither the manufacturer or distributor of this module is responsible of damages of any kind indirectly or directly caused by this module, except for the replacement of this module in case of manufacturing defects. This module must be install by qualified technician. This instruction guide may change without notice. Visit [www.ifar.ca](http://www.ifar.ca) to get latest version.



# VOLKSWAGEN Passat

## 2006-2008



# CAN-SL2

Fabriqu  au Canada Rev. B - 09 / 02 / 2009  
Site internet <http://www.ifar.ca>

MODULE D'INTERFACE CAN BUS POUR ALARME ET D MARREUR   DISTANCE

### Fonctionnel if equipped

- |  |  |  |   |
|--|--|--|---|
| <input checked="" type="checkbox"/> Verrouillage   | <input checked="" type="checkbox"/> Tach             | <input type="checkbox"/> Radio Off           | <input type="checkbox"/> Si ges chauffants        |
| <input checked="" type="checkbox"/> D verrouillage | <input checked="" type="checkbox"/> Active D marreur | <input type="checkbox"/> Transponder Bypass  | <input checked="" type="checkbox"/> Porte essence |
| <input checked="" type="checkbox"/> Armement       | <input checked="" type="checkbox"/> Status de Porte  | <input type="checkbox"/> PK3, Passlock       | <input type="checkbox"/> Contr le portes          |
| <input checked="" type="checkbox"/> D sarmement    | <input checked="" type="checkbox"/> Status de Valise | <input type="checkbox"/> Portes Coulissantes | <input type="checkbox"/> Hayon arri re            |
| <input checked="" type="checkbox"/> Valise         | <input checked="" type="checkbox"/> Status de Capot  | <input type="checkbox"/> D givrage           | <input type="checkbox"/> Signal de Frein          |

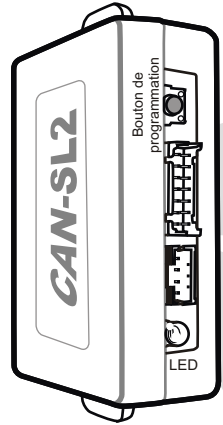

vue de face du module

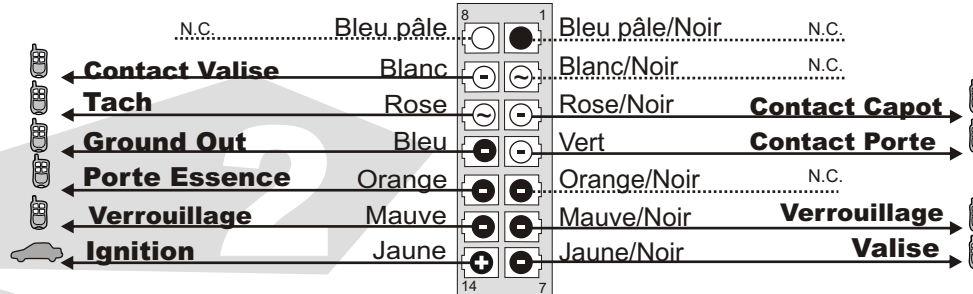

conn. 1

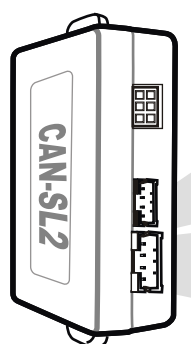
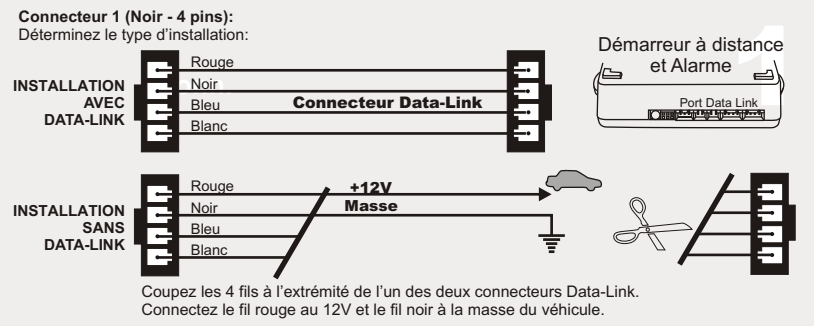

Vue de dos du module

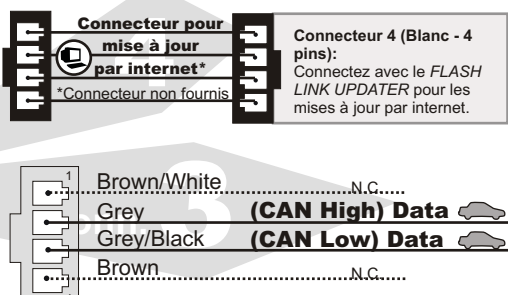

Paire de fils torsad s situ s dans le panneau lat ral du c t  chauffeur ou   la colonne de direction

Branchement du filage au d marreur   distance/Alarme Branchement du filage au v hicule O SORTIE ● ENTR E

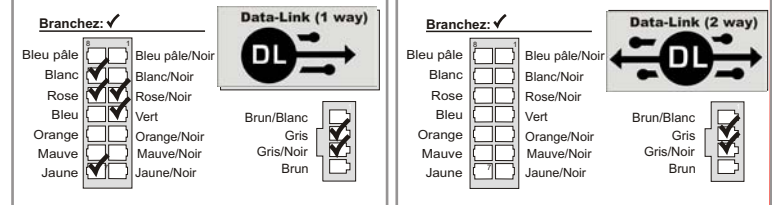

Effectuez les connexions du CAN-SL2 au v hicule:

**1 1.A** Connecteur 1 (Noir):  
D terminez le type d'installation (Data-Link ou non Data-Link) Pour l'installation DATA-LINK assurez vous de la pr sence du connecteur DATA-LINK sur le d marreur.. Pour installation non Data-Link voir INSTALLATION SANS DATA-LINK.

**1.B** Connecteur 2 (Blanc):  
Effectuez les branchements

**1.C** Connecteur 3 (Blanc, situ  au dos du module):  
Effectuez les branchements

**2** Maintenez le bouton de programmation enfonc  en ins rant le connecteur 1 dans le CAN-SL2. Le DEL s'allume pour indiquer le d but de la programmation, rel chez le bouton de programmation.

**3** Branchez le connecteur 2 (CONN. 2)  
**ATTENTION: Ne pas brancher le connecteur   l'envers.**

**4** Branchez le connecteur 3 (CONN. 3)

**5** Tournez la clef en position ignition.

**6** Lorsque le DEL clignote rapidement, tournez la clef en position OFF.  
**Le DEL s' teint pour indiquer que le module est programm .**



Support Technique:  
TEL: 514-255-HELP (4357)  
FAX: 514-255-1367  
Site internet: [www.ifar.ca](http://www.ifar.ca)

Ni le manufacturier, ni le distributeur ne se consid rent responsables des dommages caus s ou ayant pu  tre caus s, indirectement ou directement, par ce module, except  le remplacement de ce module en cas de d fectuosit  de fabrication. Ce module doit  tre install  par un technicien qualifi . Ce guide d'installation peut faire l'objet de changement sans pr avis. Consultez le [www.ifar.ca](http://www.ifar.ca) pour voir la plus r cente version.