

ADDENDUM - SUGGEST WIRING CONFIGURATION

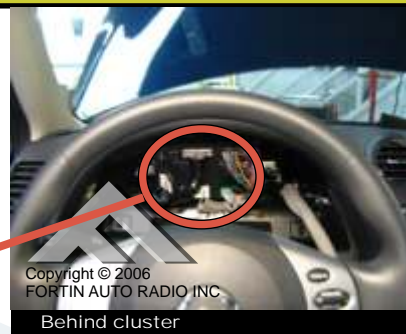

PUSH TO



Copyright © 2006
FORTIN AUTO RADIO INC.
Behind cluster



Copyright © 2008, FORTIN AUTO RADIO INC.
Engine Compartment (Battery side)



Parts required
4 diodes (1 Amp.)
1 to 4 Relay(s)

VEHICLE FIT GUIDE

Vehicles Véhicules	Years Années	Verrouillage Déverrouillage	Annement Unlock	Dépannement Disarm	Touche Tach	Future option sans ses options	Door trigger sans ses options	Trunk trigger sans ses options	Hood trigger sans ses options	Radio Off	Transporter	Passlock	Panic	Sliding glass door	Dégrillage	Défrost	Heat Seats	Catalytic Converter	Gas color	Roll Over Protection	Hatch arrière	Hatch	Vehicles Data Wire Color couleur de fil	
																								A
NISSAN	04 05 06 07 08 09 10																							
Altima																								CAN High: Blue CAN Low: Pink

WIRING SCHEMATIC CONFIGURATION CAN-SL2 OR CAN-SL-PL

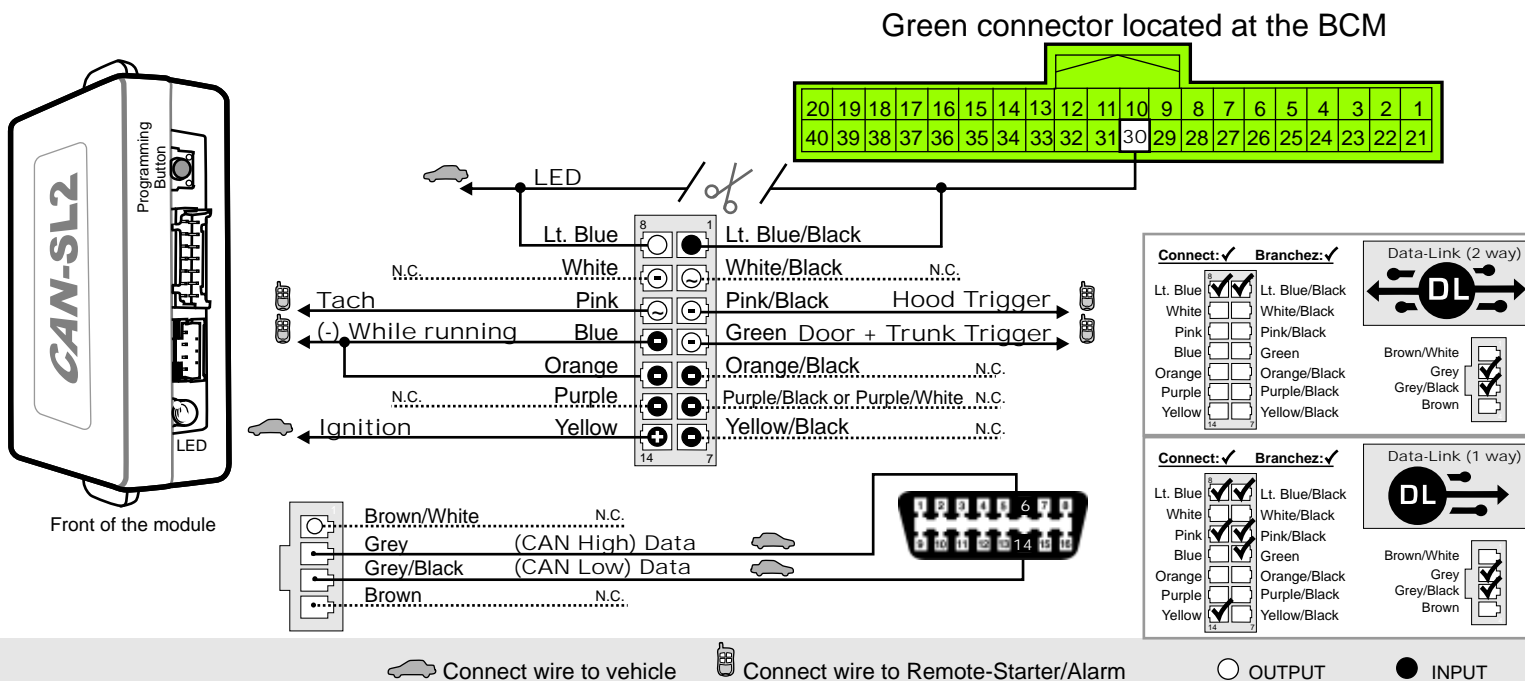

INSTALLATION WITH DATA-LINK

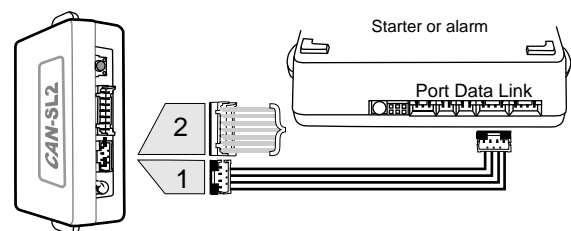

INSTALLATION WITHOUT DATA-LINK

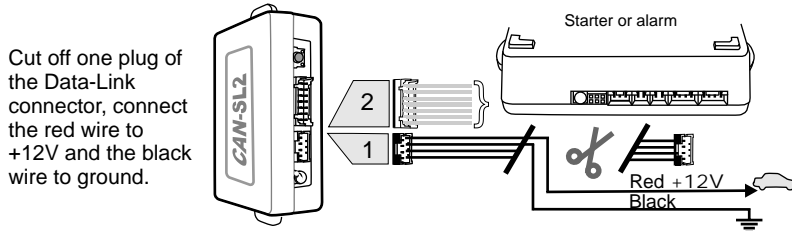

SUGGEST WIRING SCHEMATIC CONFIGURATION AT BCM BEHIND THE DASH BORD

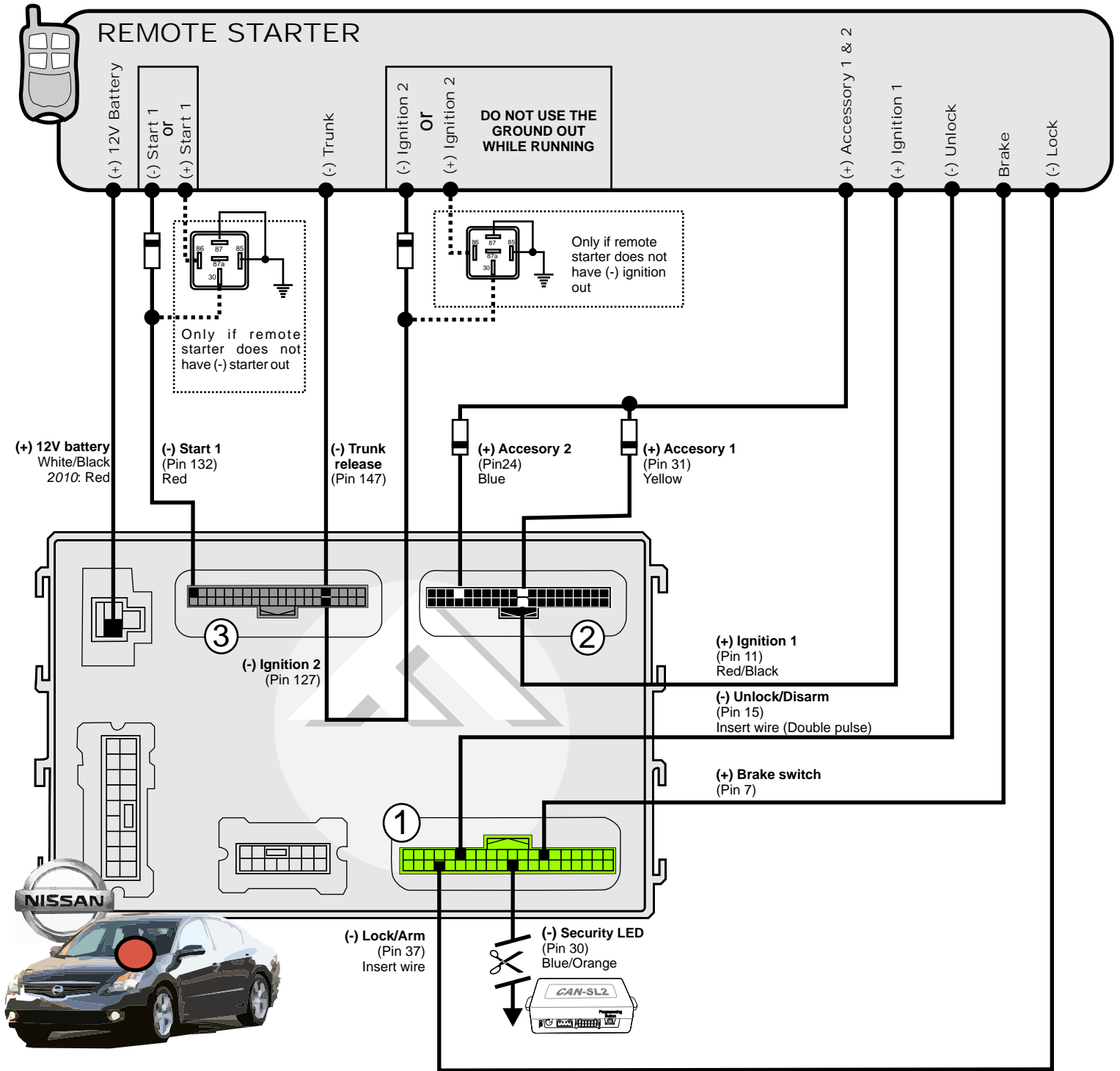

GREEN CONNECTOR

BLACK CONNECTOR

GREY CONNECTOR



SUGGEST WIRING SCHEMATIC CONFIGURATION AT FUSED BOX UNDER THE HOOD

CAUTION : PRECAUTIONS MUST BE TAKEN WITH THE INSTALLATION OF THIS RELAY. AN ERROR MAY HAVE SERIOUS CONSEQUENCES. AN INCORRECT CONNECTION CAN ALLOW THE VEHICLE TO START IN GEAR



(+) Neutral safety switch
 (Pin 30)
 Red/Black
 2010: Brown



Voltage Test: (3 states)
 Key OFF: 0 Volts
 Key ON, Transmission in Park: 12 Volts
 Key ON, Transmission in Drive: 0 Volts

(1 Amp. Diode)

(+) 12V Battery 2
 (Pin 36)
 Green

(-) Start 2
 (Pin 46)
 Red
 2010: Brown

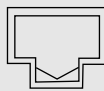
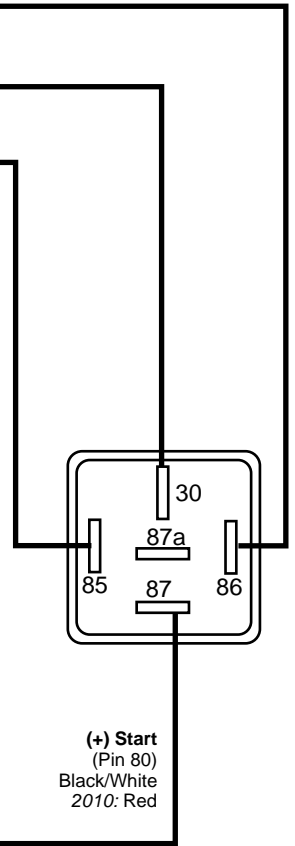
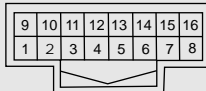
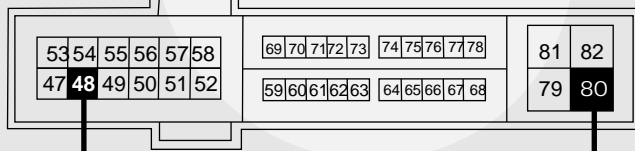
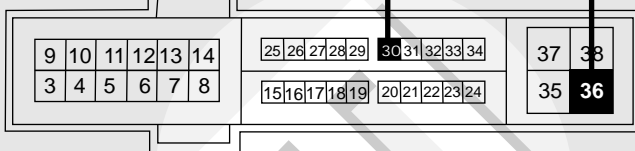

This wire must be connected in order for the air conditioning to function during remote start.

(+) Accessory 3
 (Pin 48)
 Yellow/Red
 2010: White



(+) Parking Lights
REMOTE STARTER
 (+) Accessory 3

Fuse box Driver Kick Panel

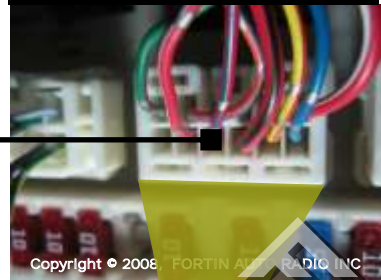

ADDENDUM - SUGGEST INSTALLATION AND PROGRAMMING INSTRUCTIONS

1 Make the connections of the CAN-SL2 to the vehicle:

1.A Connector 1 (Black):
Determine the type of installation:
INSTALLATION WITH DATA-LINK (See P.1)
INSTALLATION WITHOUT DATA-LINK (See P.1)

1.B Connector 2 (White):
Make the connections

1.C Connector 3 (White, located at the back of the module):
Make the connections

2 Press the programming switch while inserting the main wires harness (CONN 1) into the CAN-SL2 module.
The LED will illuminate to indicate you are in programming mode, release the programming button.

3 Connect the other connectors (CONN. 2)

4 Connect the other connectors (CONN. 3)

5 Press the PUSH TO START button twice to turn on the ignition.
(Do not press the brake pedal)

6 Once the LED starts to flash rapidly press the PUSH TO START button once to shut off the ignition.
The LED will turn off to indicate the module has been programmed.
The module is now ready for use.

WIRING COLOR

DESCRIPTION	COLOR		LOCATION	POLARITY	FIGURE
	2007-2009	2010			
Transponder Bypass	CAN-SL2	CAN-SL2	OBD2		
Battery 1	White/Black	Red	Top of BCM, Pin 3	Pos	P.2
Ignition 1	Red/Black	Red/Black	BCM, Pin 11, Black Connector	Pos	P.2 #2
Ignition 2	Brown/White	Brown/White	BCM, Pin 127, Grey con.	Neg	P.2 #3
Accessory 1	Yellow	Yellow	BCM, Pin 31, Black Connector	Pos	P.2 #2
Accessory 2	Blue	Blue	BCM, Pin 24, Black Connector	Pos	P.2 #2
Accessory 3	Yellow/Red	White	Fuse box under the hood pin 48	Pos	P.3
Start 1	Red	Red	BCM, Pin 132, Grey con.	Neg	P.2 #3
Start 2	Red	Brown	Under hood, fuse Panel pin 46	Neg	P.3
Start 3	Black/White	Red	Under hood, fuse Panel pin 80	Pos	P.3
Lock	Empty spot	Empty spot	BCM, Pin 37, green con.	Neg	P.2 #1
Unlock	Empty spot	Empty spot	BCM, Pin 15, green con.	Neg	P.2 #1
Arm	Same as Lock	Same as Lock			
Disarm	Same as Unlock	Same as Unlock			
Driver door pin	Light Blue	Light Blue	BCM, Pin 39, green con.	Neg	
Door status	CAN-SL2	CAN-SL2			
Hood status	CAN-SL2	CAN-SL2	If equipped with OEM hood pin.		
Trunk status	CAN-SL2	CAN-SL2			
Trunk release	Blue/Red	Blue/Red	BCM, Pin 36, Grey con.	Neg	P.2 #3
Parking light	Red/Blue	Red/Blue	Fuse Panel	Pos	P.3
Security light	Blue/Orange	Blue/Orange	BCM, Pin 30, Green con.	Neg	P.2 #1
Hand Brake	Light Green/Red	Light Green/Red			
Brake switch	Red/Green	Red/Green	BCM, Pin 7, green con.	Pos	P.2 #1
Tach	CAN-SL2	CAN-SL2			
Horn	Blue/White	Blue/White	Steering column	Neg	
Neutral safety switch	Red/Black	Brown	Under hood Fuse Panel, Pin 30	Pos	P.3
CAN high	Blue	Blue	BCM, Pin 20, Black con.	Data	P.2 #2
CAN low	Pink	Pink	BCM, Pin 19 Black con.	Data	P.2 #2

WARNING / INFORMATION

The information on this sheet is provided on an (as is) basis with no representation or warranty of accuracy whatsoever. It is the sole responsibility of the installer to check and verify any circuit before connecting to it. Only a computer safe logic probe or digital multimeter should be used. FORTIN Electronic system assumes absolutely no liability or responsibility whatsoever pertaining to the accuracy or currency of the information supplied. The installation in every case is the sole responsibility of the installer performing the work and FORTIN Electronic system assumes no liability or responsibility whatsoever resulting from any type of installation, whether performed properly, improperly or any other way. Neither the manufacturer or distributor of this module is responsible of damages of any kind indirectly or directly caused by this module, except for the replacement of this module in case of manufacturing defects. This module must be installed by qualified technician. The information supplied is a guide only. This instruction guide may change without notice. Visit www.ifar.ca to get latest version.

Technical support:
TEL: 514-255-HELP (4357)
FAX: 514-255-1367
Web: www.ifar.ca



ADDENDUM - SCHEMA DE BRANCHEMENT SUGGÉRÉ



PUSH TO



Copyright © 2006 FORTIN AUTO RADIO INC
Derrière l'odomètre



Copyright © 2008, FORTIN AUTO RADIO INC
Compartiment moteur (Côté batterie)



Pièces requises
4 diodes (1 amp.)
1 à 4 Relais

GUIDE DES VEHICULES

Vehicles Véhicules	Years Années	Verrouillage	Déverrouillage	Arnement	Désarmement	Disarm	Trunk	Tach	Fiture option	Door trigger sans ses poignées	Trunk trigger sans de la valise	Hood trigger	Radio Off	Transporter	Passlock	Panic alarm	Sliding glass	Déglace	Défrost	Sièges & Heat Seats	Catalytic Converter	Gas color	Roll Over	Hatch	Hatch arrière	Vehicles Data	Wire Color	Vehicles et couleur de fil
NISSAN	04 05 06 07 08 09 10																											
Altima																												CAN High: Blue CAN Low: Pink

SCHÉMA DE BRANCHEMENT CAN-SL2 OU CAN-SL-PL

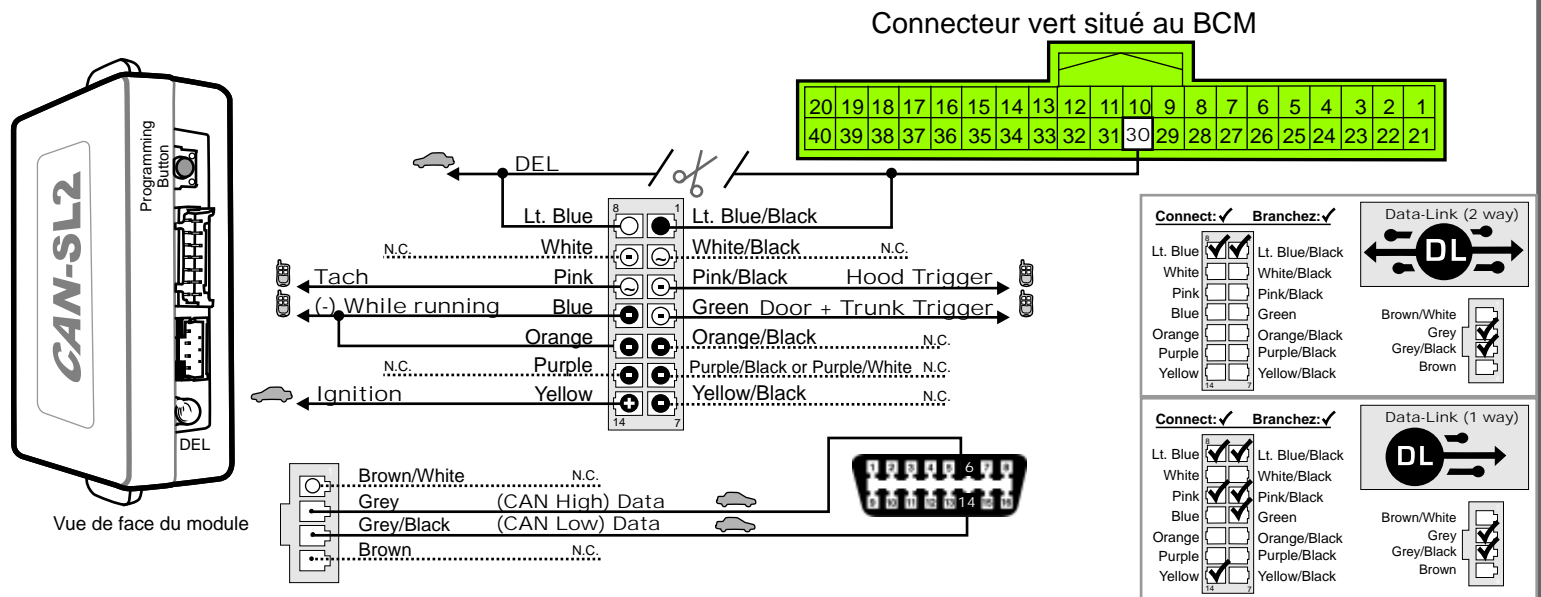

Branchement du filage au démarreur à distance/Alarme

Branchement du filage au véhicule

○ SORTIE ● ENTRÉE

INSTALLATION AVEC DATA-LINK

INSTALLATION SANS DATA-LINK

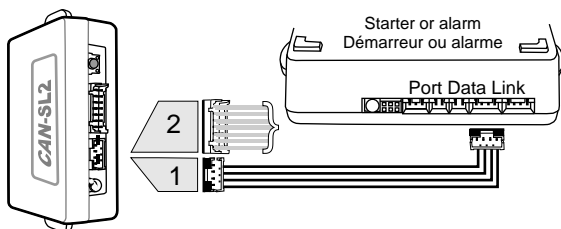

Coupez les 4 fils à l'extrémité de l'un des deux connecteurs Data-Link. Connectez le fil rouge au 12V et le fil noir à la masse du véhicule.



SCHÉMA DE BRANCHEMENT SUGGÉRÉ AU BCM DERRIÈRE ODOMÈTRE



CONNECTEUR VERT

CONNECTEUR NOIR

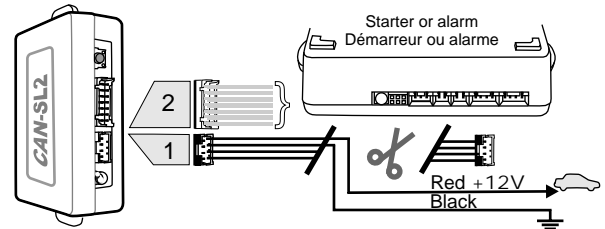
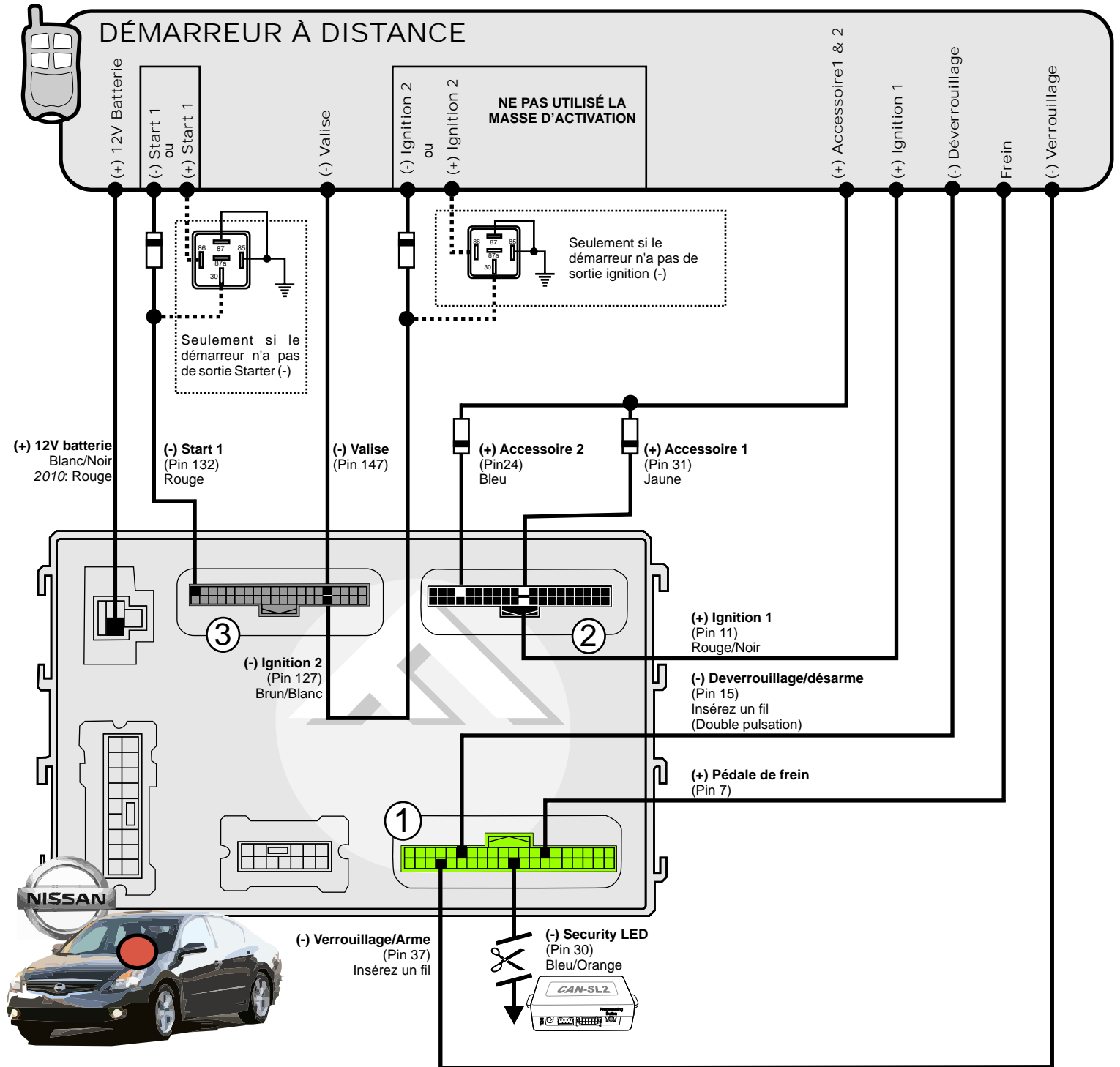
CONNECTEUR GRIS



SCHÉMA DE BRANCHEMENT SUGGÉRÉ À LA BOÎTE DE FUSIBLE SOUS LE CAPOT

ATTENTION: L'INSTALLATION DE CE RELAIS DOIT ÊTRE FAITE AVEC PRÉCAUTION : UN MAUVAIS BRANCHEMENT PEUT ENTRAÎNER DE GRAVES CONSÉQUENCES. LE VÉHICULE PEUT DÉMARRER EMBRAYÉ.

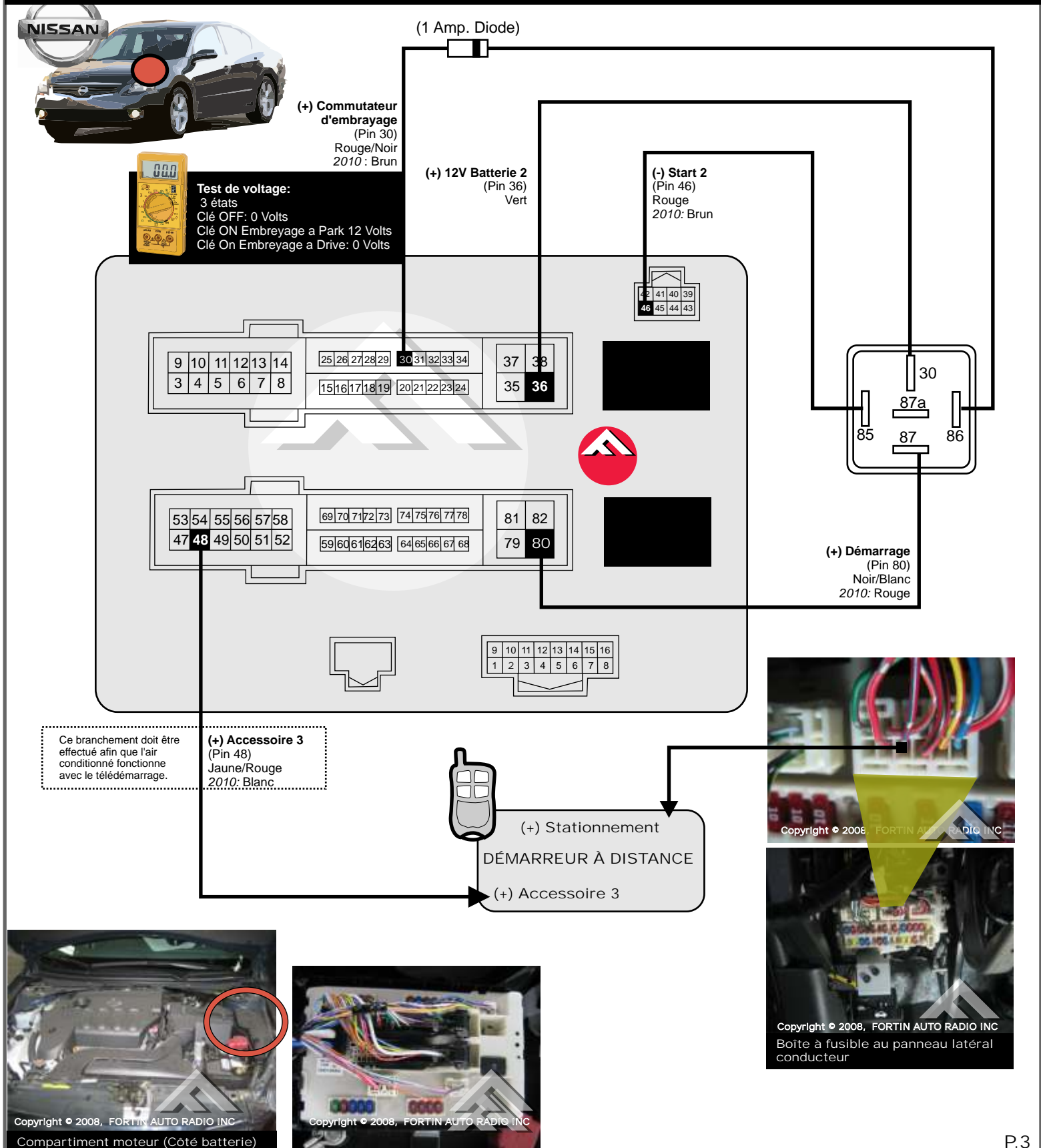

ADDENDUM - INSTRUCTIONS D'INSTALLATION SUGGÉRÉ ET DE PROGRAMMATION

Effectuez les connexions du CAN-SL2 au véhicule:

1

1.A **Connecteur 1 (Noir):**
Déterminez le type d'installation (**Data-Link** ou **non Data-Link**)
Pour l'installation DATA-LINK assurez vous de la présence du connecteur DATA-LINK sur le démarreur. (Voir INSTALLATION AVEC DATA-LINK (P.1)).
Pour installation non Data-Link voir INSTALLATION SANS DATA-LINK (P.1).

1.B **Connecteur 2 (Blanc):**
Faire les branchements

1.C **Connecteur 3 (Blanc, situé au dos du module):**
Faire les branchements

2

Maintenez le bouton de programmation enfoncé en insérant le connecteur 1 dans le CAN-SL2.
Le DEL s'allume pour indiquer le début de la programmation, relâchez le bouton de programmation.

3

Branchez le connecteur 2 (CONN. 2)

4

Branchez le connecteur 3 (CONN. 3)

5

x2 ON
Appuyez 2 fois sur le bouton démarrage (Push to start) pour allumer l'ignition. (Ne pas appuyer sur la pédale de frein)

6

x1 OFF
Lorsque le DEL clignote rapidement, appuyez une fois sur le bouton démarrage (Push To Start) pour éteindre l'ignition.
Le DEL s'éteint pour indiquer que le module est programmé.

COULEUR DES FILS

DESCRIPTION	COULEUR		EMPLACEMENT	POLARITÉ	FIGURE
	2007-2009	2010			
Anti-vol passif	CAN-SL2	CAN-SL2	OBD2		
Batterie 1	Blanc/Noir	Rouge	Dessus du BCM, Pin 3	Pos	P.2
Ignition 1	Rouge/Noir	Rouge/Noir	BCM, Pin 11, Connecteur noir	Pos	P.2 #2
Ignition 2	Brun/Blanc	Brun/Blanc	BCM, Pin 127, con. gris	Neg	P.2 #3
Accessoire 1	Jaune	Jaune	BCM, Pin 31, Connecteur noir	Pos	P.2 #2
Accessoire 2	Bleu	Bleu	BCM, Pin 24, Connecteur noir	Pos	P.2 #2
Accessoire 3	Jaune/Rouge	Blanc	Panneau fusible sous capot pin 48	Pos	P.3
Start 1	Rouge	Rouge	BCM, Pin 132, con. gris	Neg	P.2 #3
Start 2	Rouge	Brun	Panneau fusible sous capot pin 46	Neg	P.3
Start 3	Noir/Blanc	Rouge	Panneau fusible sous capot pin 80	Pos	P.3
Verrouillage	Place vide	Place vide	BCM, Pin 37, con. vert	Neg	P.2 #1
Déverrouillage	Place vide	Place vide	BCM, Pin 15, con. vert	Neg	P.2 #1
Armement	Voir verrouillage	Voir verrouillage			
Désarmement	Voir déverrouillage	Voir déverrouillage			
Porte conducteur	Bleu pâle	Bleu pâle	BCM, Pin 39, con. vert	Neg	
Contact portes	CAN-SL2	CAN-SL2			
Contact capot	CAN-SL2	CAN-SL2	Si équipé d'un pin de capot d'origine		
Contact valise	CAN-SL2	CAN-SL2			
Valise	Bleu/Rouge	Bleu/Rouge	BCM, Pin 36, con. gris	Neg	P.2 #3
Feux de stationnement	Rouge/Bleu	Rouge/Bleu	Panneau fusible	Pos	P.3
Lumière de sécurité	Bleu/Orange	Bleu/Orange	Tableau de bord ou BCM, pin 30, con. vert	Neg	P.2 #1
Frein à main	Vert pâle/Rouge	Vert pâle/Rouge		Neg	
Commutateur frein	Rouge/Vert	Rouge/Vert	BCM, Pin 7, con. vert	Pos	P.2 #1
Tach	CAN-SL2	CAN-SL2			
Klaxon	Bleu/Blanc	Bleu/Blanc	Colonne de direction	Neg	
Commutateur d'embrayage	Rouge/Noir	Brun	Sous le capot Panneau fusible, Pin 30	Pos	P.3
CAN high	Bleu	Bleu	BCM, Pin 20, con. Black	Data	P.2 #2
CAN low	Rose	Rose	BCM, Pin 19, con. Black	Data	P.2 #2

MISE EN GARDE / SUPPORT TECHNIQUE

L'information de ce guide est fournie sur la base de représentation (telle quelle) sans aucune garantie de précision et d'exactitude. Il est de la seule responsabilité de l'installateur de vérifier tous les fils et circuit avant de effectuer les connexions. Seule une sonde logique ou un multimètre digital doivent être utilisés. FORTIN Electronic systems n'assume aucune responsabilité de l'exactitude de l'information fournie. L'installation (dans chaque cas) est la responsabilité de l'installateur effectuant le travail. FORTIN Electronic system n'assume aucune responsabilité suite à l'installation, que celle-ci soit bonne ou mauvaise ou de n'importe autre type. Ni le fabricant, ni le distributeur ne se considèrent responsables des dommages causés ou ayant pu être causés, indirectement ou directement, par ce module, excepté le remplacement de ce module en cas de défaut de fabrication. Ce module doit être installé par un technicien qualifié. L'information fournie dans ce guide est une suggestion. Ce guide d'instruction peut faire l'objet de changement sans préavis. Consultez le www.ifar.ca pour voir la plus récente version.

Support Technique:
TEL: 514-255-HELP (4357)
FAX: 514-255-1367
Web: www.ifar.ca

FORTIN
SYSTÈMES ÉLECTRONIQUES