

NISSAN SKYLINE

Copyright © 2008, FORTIN AUTO RADIO INC ALL RIGHTS RESERVED

INSTALLATION GUIDE

Made in Canada -Rev. C - 04 / 06 / 2010
Web site: <http://www.ifar.ca>

ADDENDUM - SUGGEST WIRING CONFIGURATION

FORTIN
ELECTRONIC SYSTEMS

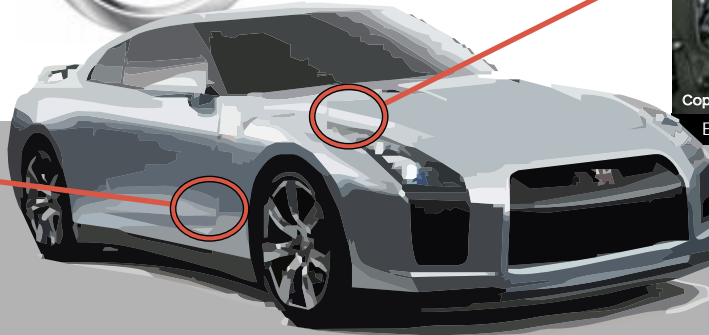

Copyright © 2008, FORTIN AUTO RADIO INC
Engine Compartment (Battery side)

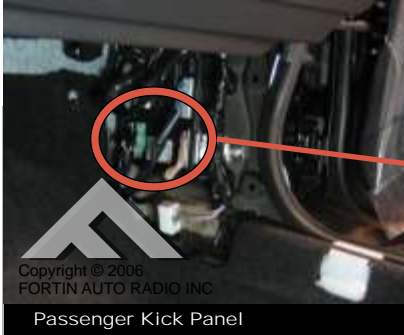

Copyright © 2008, FORTIN AUTO RADIO INC
Passenger Kick Panel

Parts required
4 diodes (1 Amp.)
1 to 4 Relay(s)

VEHICLE FIT GUIDE

Vehicles Véhicules	Years Années	Verrouillage	Déverrouillage	Alimentation	Désarmement	Disarm	Trunk	Tech	Futur option	Statut des portes	Door trigger	Statut de la valise	Trunk trigger	Hood trigger	Radio Off	Transporter	Passport	P.K.C.	Sliding doors	Déglacage	Déglacage	Sièges chauffants	Heat Seats	Capot/mot. essence	Gas door	Roll Down	Witfchows	Hayon arrière	Hatch	Vehic Data	Données du véhicule et couleur de fil
NISSAN		A	B	C	D	E	F	G	H	I	J	K	L	M	N	O	P	Q	R	S									U		
Skyline	04 05 06 07 08 09	•					•	•		•	•	•	•	•																CAN High: Blue, CAN Low: Pink	

WIRING SCHEMATIC CONFIGURATION CAN-SL2

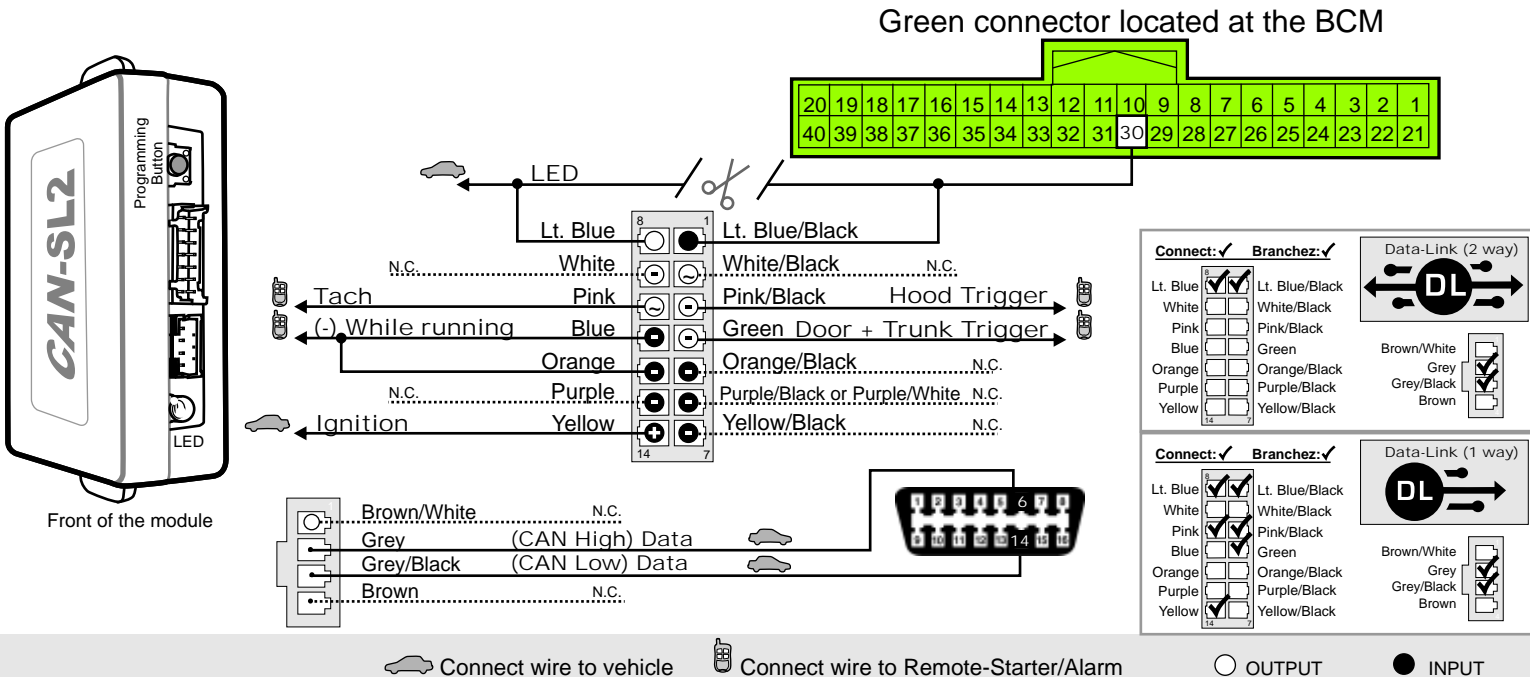

INSTALLATION WITH DATA-LINK

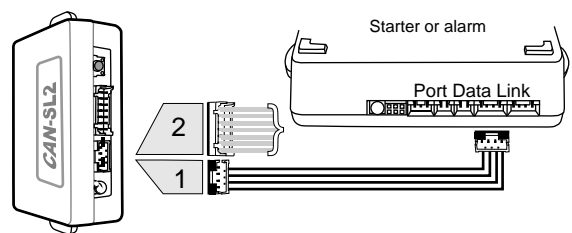

INSTALLATION WITHOUT DATA-LINK

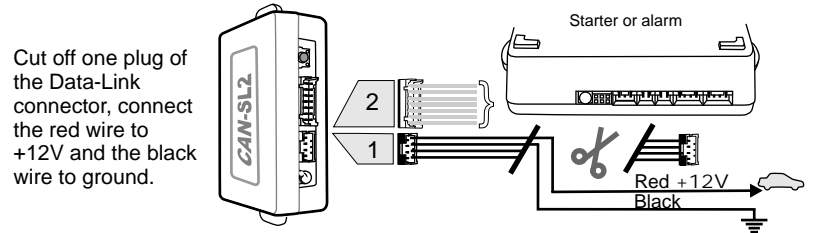

SUGGEST WIRING SCHEMATIC CONFIGURATION AT BCM AT PASSENGER KICK PANEL

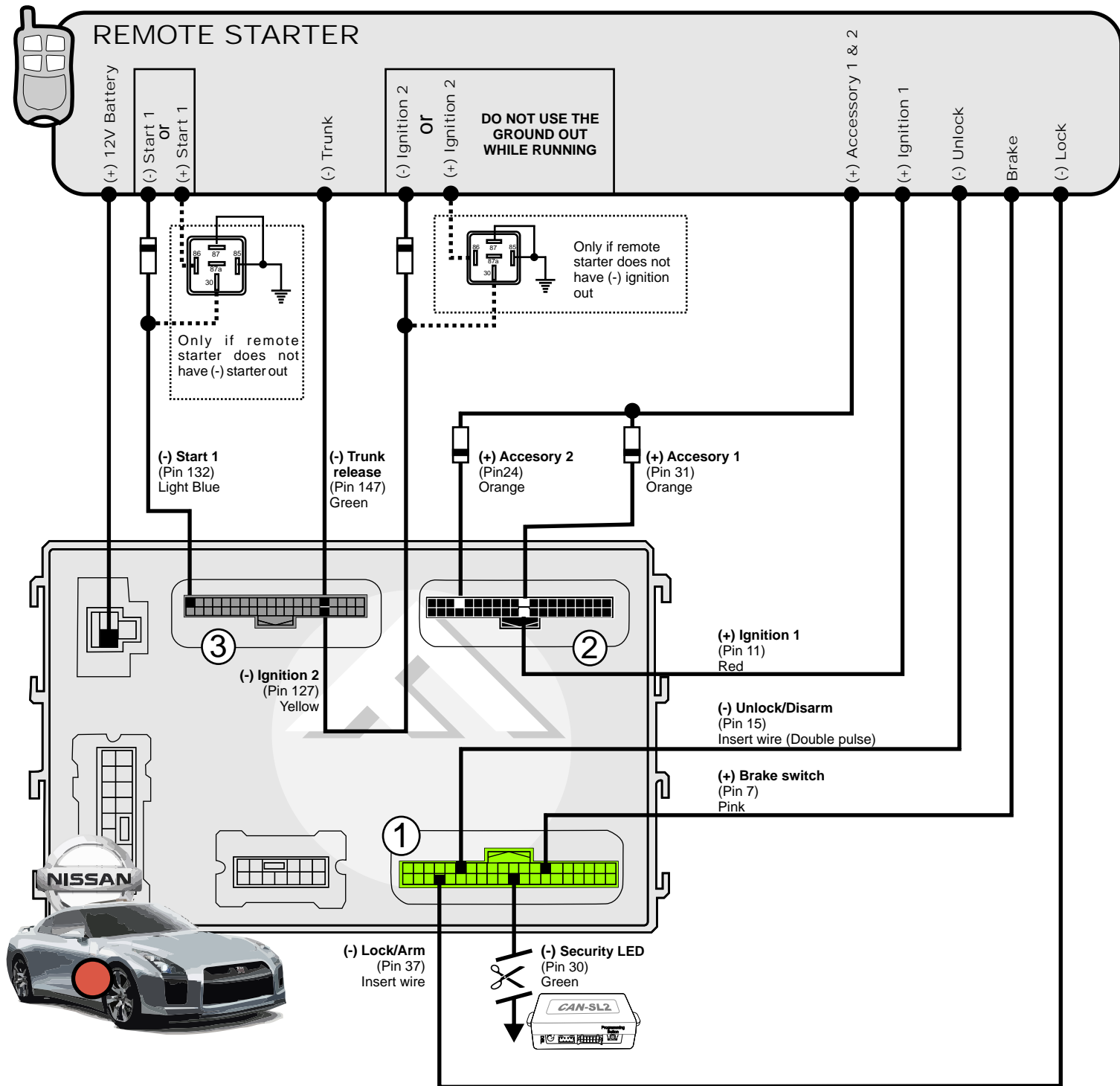

GREEN CONNECTOR

BLACK CONNECTOR

GREY CONNECTOR



SUGGEST WIRING SCHEMATIC CONFIGURATION AT FUSED BOX UNDER THE HOOD

CAUTION : PRECAUTIONS MUST BE TAKEN WITH THE INSTALLATION OF THIS RELAY. AN ERROR MAY HAVE SERIOUS CONSEQUENCES. AN INCORRECT CONNECTION CAN ALLOW THE VEHICLE TO START IN GEAR

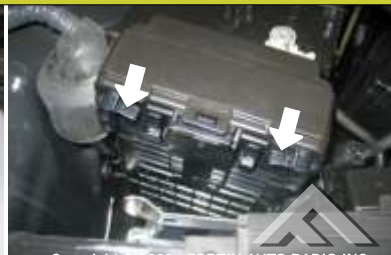
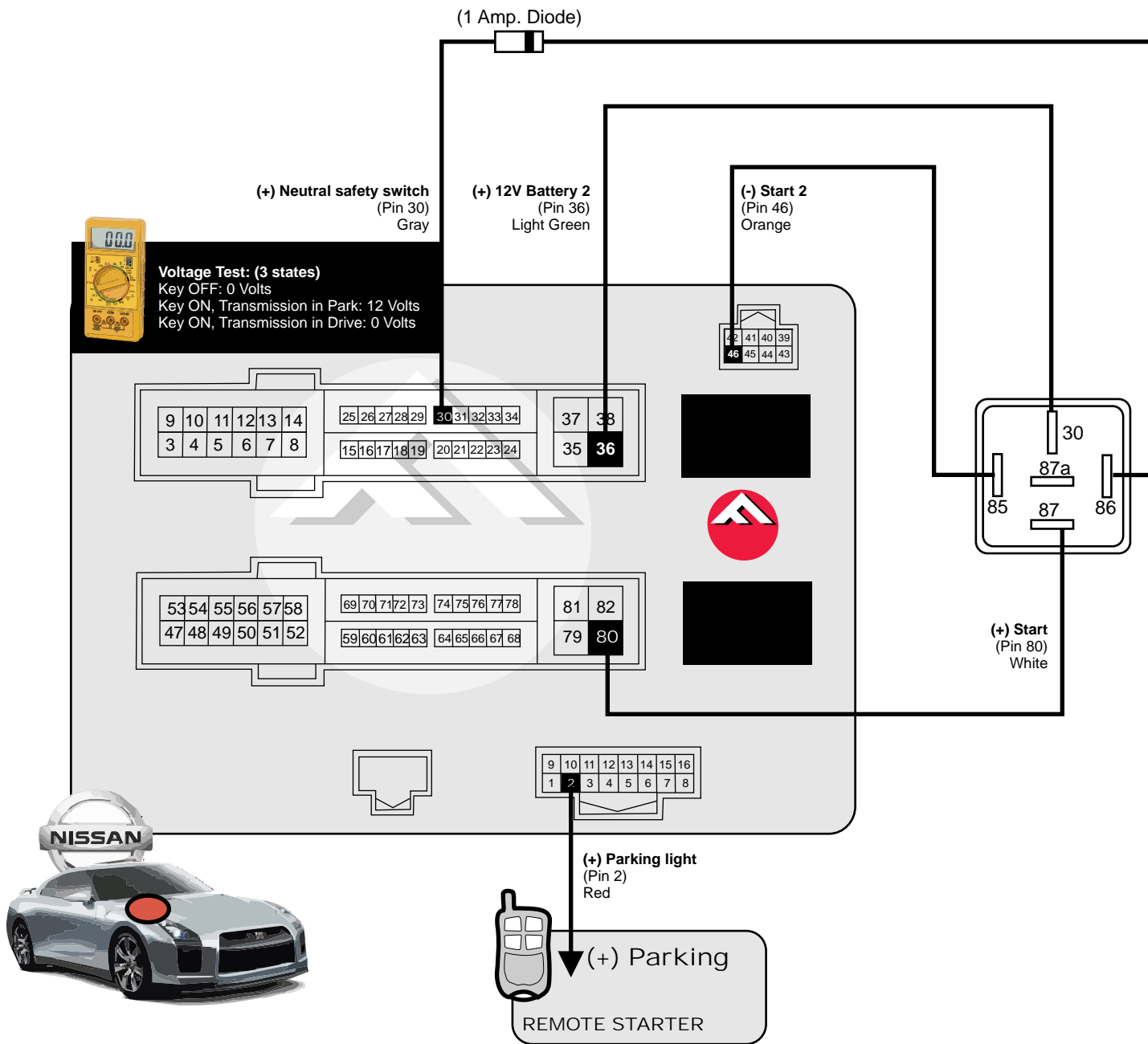

ADDENDUM - INSTALLATION AND PROGRAMMING INSTRUCTIONS

1 Make the connections of the CAN-SL2 to the vehicle:

1.A Connector 1 (Black):
Determine the type of installation:
INSTALLATION WITH DATA-LINK (See P.3)
INSTALLATION WITHOUT DATA-LINK (See P.3)

1.B Connector 2 (White):
Make the connections associated with the vehicle in the VEHICLE FIT GUIDE (P.3)

1.C Connector 3 (White, located at the back of the module):
Make the connections associated with the vehicle in the VEHICLE FIT GUIDE (P.3)

2 Press the programming switch while inserting the main wires harness (CONN 1) into the CAN-SL2 module.
The LED will illuminate to indicate you are in programming mode, release the programming button.

3 Connect the other connectors (CONN. 2)

4 Connect the other connectors (CONN. 3)

5 Press the PUSH TO START button twice to turn on the ignition.
(Do not press the brake pedal)

6 Once the LED starts to flash rapidly press the PUSH TO START button once to shut off the ignition.
The LED will turn off to indicate the module has been programmed.

The module is now ready for use.

WIRING COLOR

DESCRIPTION	COLOR	LOCATION	POLARITY	FIGURE
Transponder Bypass	CAN-SL2	OBD2		
Battery 1	White	Top of BCM, Pin 3	Pos	P.2
Ignition 1	Red	BCM, Pin 11, Black Connector	Pos	P.2 #2
Ignition 2	Yellow	BCM, Pin 127, Grey con.	Neg	P.2 #3
Accessory 1	Orange	BCM, Pin 31, Black Connector	Pos	P.2 #2
Accessory 2	Orange	BCM, Pin 24, Black Connector	Pos	P.2 #2
Start 1	Light Blue	BCM, Pin 132, Grey con.	Neg	P.2 #3
Start 2	Orange	Under hood, fuse Panel pin 46	Neg	P.3
Start 3	White	Under hood, fuse Panel pin 80	Pos	P.3
Lock	Empty spot	BCM, Pin 37, green con.	Neg	P.2 #1
Unlock	Empty spot	BCM, Pin 15, green con.	Neg	P.2 #1
Arm	Same as Lock			
Disarm	Same as Unlock			
Driver door pin	Gray	BCM, Pin 39, green con.	Neg	
Door status	CAN-SL2			
Hood status	CAN-SL2	If equipped with OEM hood pin.		
Trunk status	CAN-SL2			
Trunk release	Green	BCM, Pin 36, Grey con.	Neg	P.2 #3
Parking light	Red	Fuse Panel	Pos	P.3
Security light	Green	BCM, Pin 30, Green con.	Neg	P.2 #1
Hand Brake			Neg	
Brake switch	Pink	BCM, Pin 7, green con.	Pos	P.2 #1
Tach	CAN-SL2			
Horn				
Neutral safety switch	Gray	Under hood Fuse Panel, Pin 30	Pos	P.3
CAN high	Blue	BCM, Pin 20, Black con.	Data	P.2 #2
CAN low	Pink	BCM, Pin 19 Black con.	Data	P.2 #2

WARNING / INFORMATION

The information on this sheet is provided on an (as is) basis with no representation or warranty of accuracy whatsoever. It is the sole responsibility of the installer to check and verify any circuit before connecting to it. Only a computer safe logic probe or digital multimeter should be used. FORTIN Electronic system assumes absolutely no liability or responsibility whatsoever pertaining to the accuracy or currency of the information supplied. The installation in every case is the sole responsibility of the installer performing the work and FORTIN Electronic system assumes no liability or responsibility whatsoever resulting from any type of installation, whether performed properly, improperly or any other way. Neither the manufacturer or distributor of this module is responsible of damages of any kind indirectly or directly caused by this module, except for the replacement of this module in case of manufacturing defects. This module must be installed by qualified technician. The information supplied is a guide only. This instruction guide may change without notice. Visit www.ifar.ca to get latest version.

Technical support:
TEL: 514-255-HELP (4357)
FAX: 514-255-1367
Web: www.ifar.ca

FORTIN
ELECTRONIC SYSTEMS

ADDENDUM - SCHEMA DE BRANCHEMENT SUGGÉRÉ

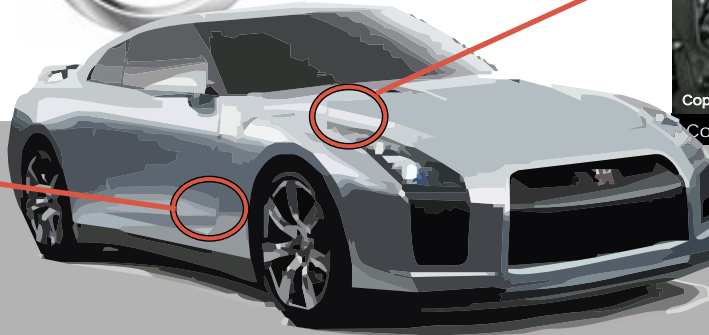

Pièces requises
4 diodes (1 amp.)
1 à 4 Relais

GUIDE DES VEHICULES

Vehicles Véhicules	Years Années	Vehicules Data																			Vehicules Data Wife Color Données du véhicule et couleur de fil											
		Verrouillage	Déverrouillage	Alimentation	Désarmement	Disarm	Trunk	Tech	Fuite option	Status des portes	Door trigger	Status de la valise	Trunk trigger	Status du capot	Hood trigger	Radio Off	Transporter	Passport	P.C.K.	Sliding doors		Déglace	Defrost	Sièges chauffés	Heat Seats	Capot/mot	Gas door	Roll Down	* Windows	Hayon arrière	Hatch	
NISSAN	04 05 06 07 08 09	A	B	C	D	E	F	G	H	I	J	K	L	M	N	O	P	Q	R	S	U	CAN High: Blue CAN Low: Pink										
Skyline																																

SCHEMA DE BRANCHEMENT CAN-SL2

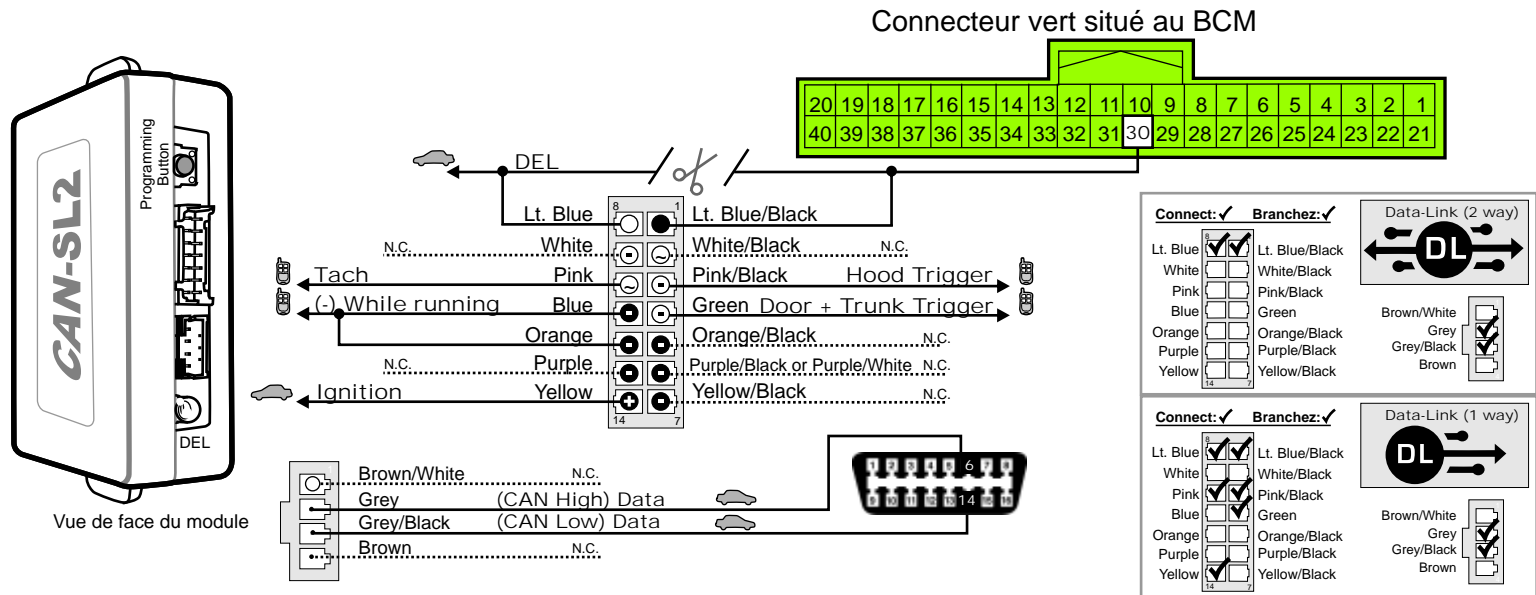

Branchement du filage au démarreur à distance/Alarme

Branchement du filage au véhicule

○ SORTIE ● ENTRÉE

INSTALLATION AVEC DATA-LINK

INSTALLATION SANS DATA-LINK

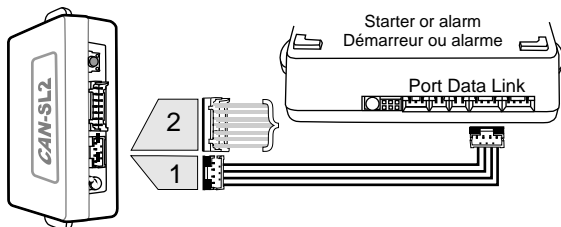

Coupez les 4 fils à l'extrémité de l'un des deux connecteurs Data-Link. Connectez le fil rouge au 12V et le fil noir à la masse du véhicule.



SCHÉMA DE BRANCHEMENT SUGGÉRÉ AU BCM DANS LE PANNEAU LATÉRAL CÔTÉ PASSAGER



CONNECTEUR VERT

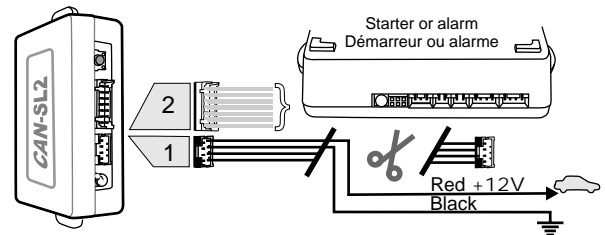
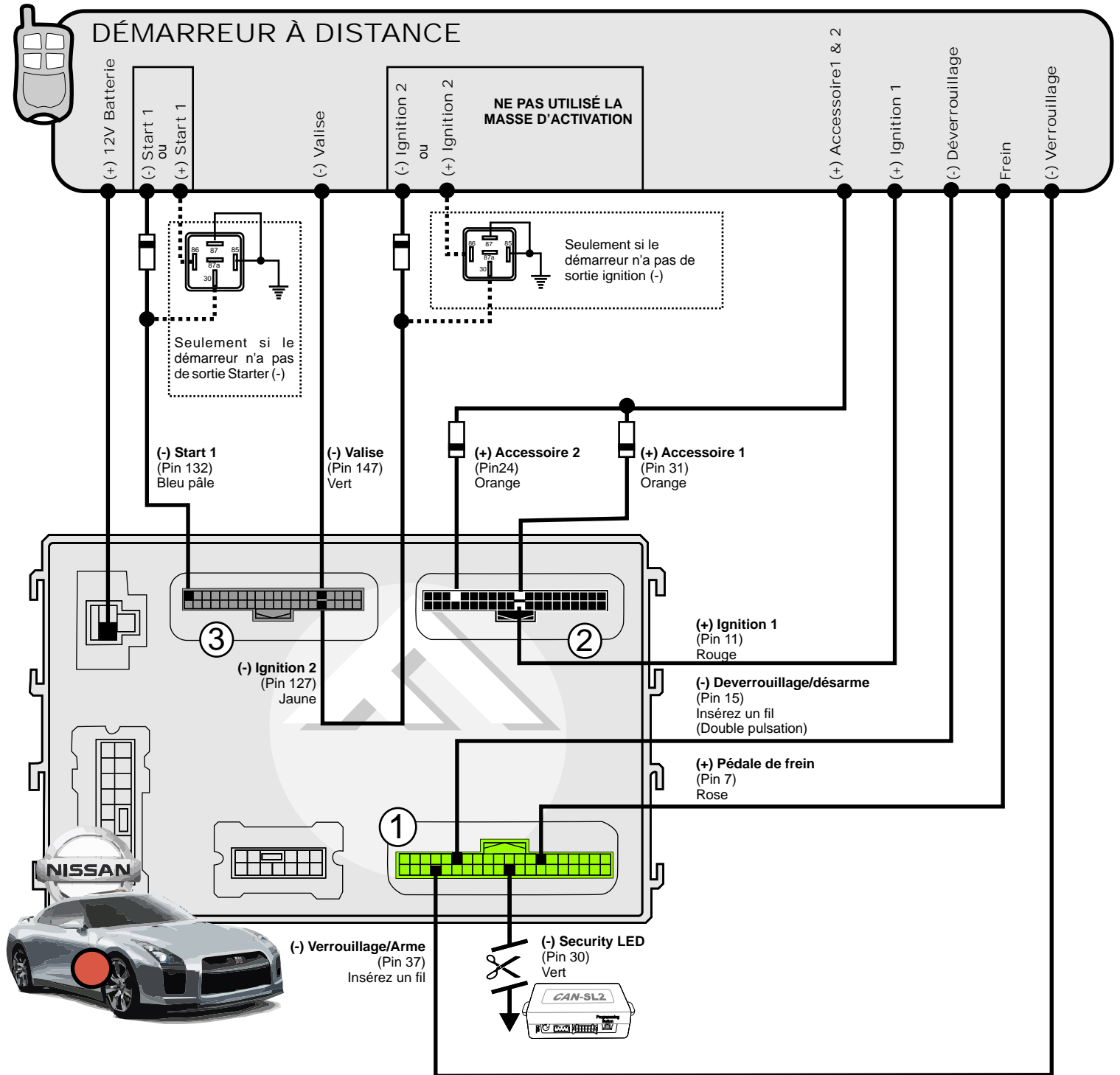

CONNECTEUR NOIR



CONNECTEUR GRIS



SCHÉMA DE BRANCHEMENT SUGGÉRÉ À LA BOÎTE DE FUSIBLE SOUS LE CAPOT

ATTENTION: L'INSTALLATION DE CE RELAIS DOIT ÊTRE FAITE AVEC PRÉCAUTION : UN MAUVAIS BRANCHEMENT PEUT ENTRAÎNER DE GRAVES CONSÉQUENCES. LE VÉHICULE PEUT DÉMARRER EMBRAYÉ.

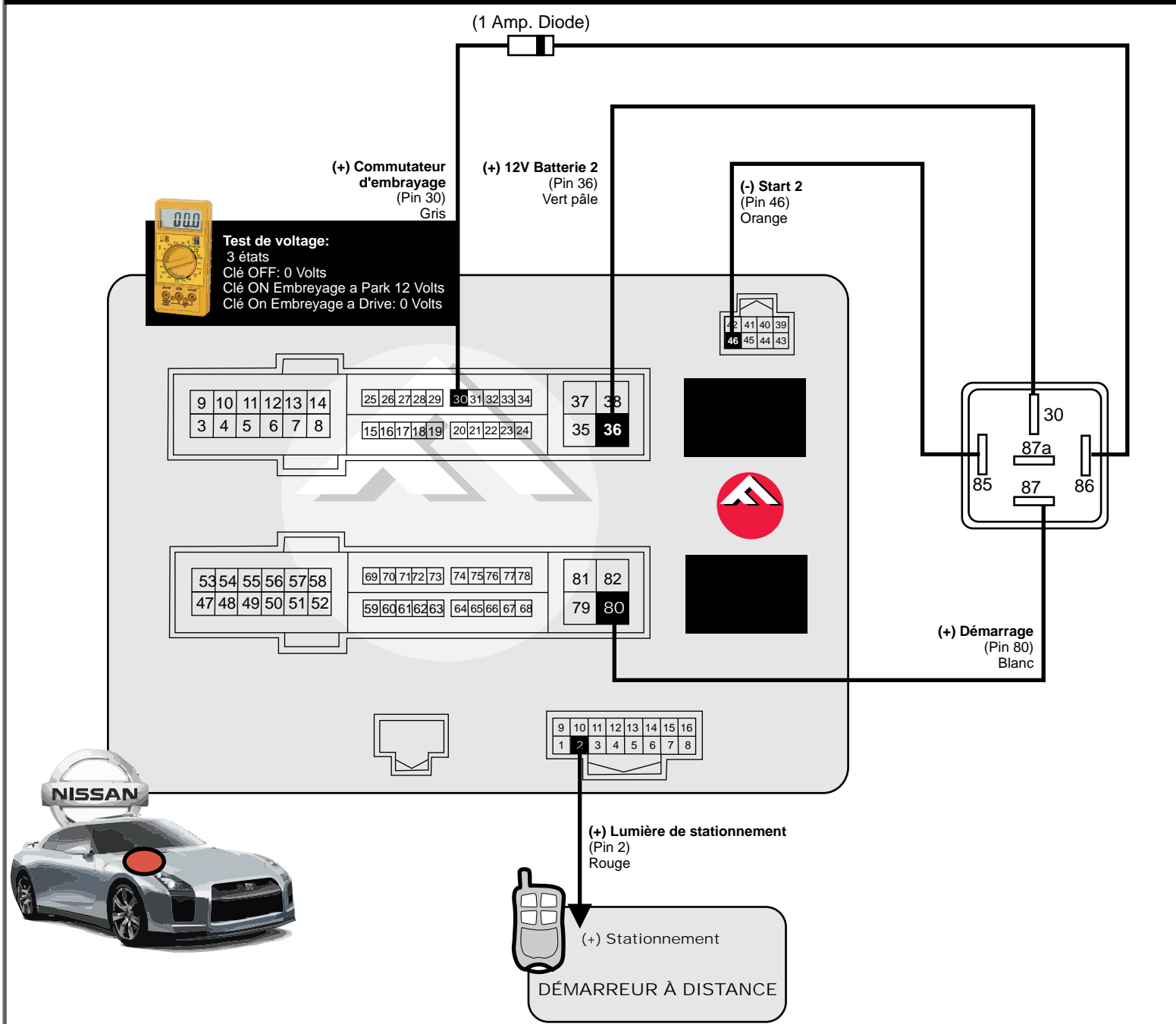

ADDENDUM - INSTRUCTIONS D'INSTALLATION ET DE PROGRAMMATION

Effectuez les connexions du CAN-SL2 au véhicule:

1
1.A
Connecteur 1 (Noir):
Déterminez le type d'installation (**Data-Link** ou **non Data-Link**)
Pour l'installation DATA-LINK assurez vous de la présence du connecteur DATA-LINK sur le démarreur. (Voir INSTALLATION AVEC DATA-LINK (P.1)).
Pour installation non Data-Link voir INSTALLATION SANS DATA-LINK (P.1).

1.B
Connecteur 2 (Blanc):
Faire les branchements

1.C
Connecteur 3 (Blanc, situé au dos du module):
Faire les branchements

2
Maintenez le bouton de programmation enfoncé en insérant le connecteur 1 dans le CAN-SL2.
Le DEL s'allume pour indiquer le début de la programmation, relâchez le bouton de programmation.

3

Branchez le connecteur 2 (CONN. 2)

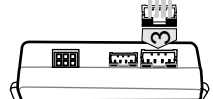
4

Branchez le connecteur 3 (CONN. 3)

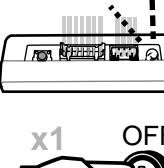
5

Appuyez 2 fois sur le bouton démarrage (Push to start) pour allumer l'ignition. (Ne pas appuyer sur la pédale de frein)

6

Lorsque le DEL clignote rapidement, appuyez une fois sur le bouton démarrage (Push To Start) pour éteindre l'ignition.
Le DEL s'éteint pour indiquer que le module est programmé.

COULEURS DES FILS

DESCRIPTION	COULEUR	EMPLACEMENT	POLARITÉ	FIGURE
Anti-voil passif	CAN-SL2	OBD2		
Batterie 1	Blanc	Dessus du BCM, Pin 3	Pos	P.2
Ignition 1	Rouge	BCM, Pin 11, Connecteur noir	Pos	P.2 #2
Ignition 2	Jaune	BCM, Pin 127, con. gris	Neg	P.2 #3
Accessoire 1	Orange	BCM, Pin 31, Connecteur noir	Pos	P.2 #2
Accessoire 2	Orange	BCM, Pin 24, Connecteur noir	Pos	P.2 #2
Start 1	Bleu pâle	BCM, Pin 132, con. gris	Neg	P.2 #3
Start 2	Orange	Panneau fusible sous capot pin 46	Neg	P.3
Start 3	Blanc	Panneau fusible sous capot pin 80	Pos	P.3
Verrouillage	Place vide	BCM, Pin 37, con. vert	Neg	P.2 #1
Déverrouillage	Place vide	BCM, Pin 15, con. vert	Neg	P.2 #1
Armement	Voir verrouillage			
Désarmement	Voir déverrouillage			
Porte conducteur	Gris	BCM, Pin 39, con. vert	Neg	
Contact portes	CAN-SL2			
Contact capot	CAN-SL2	Si équipé d'un pin de capot d'origine		
Contact valise	CAN-SL2			
Valise	Vert	BCM, Pin 36, con. gris	Neg	P.2 #3
Feux de stationnement	Rouge	Panneau fusible	Pos	P.3
Lumière de sécurité	Vert	Tableau de bord ou BCM, pin 30, con. vert	Neg	P.2 #1
Frein à main			Neg	
Commutateur frein	Rose	BCM, Pin 7, con. vert	Pos	P.2 #1
Tach	CAN-SL2			
Klaxon				
Commutateur d'embrayage	Gris	Sous le capot Panneau fusible, Pin 30	Pos	P.3
CAN high	Bleu	BCM, Pin 20, con. Black	Data	P.2 #2
CAN low	Rose	BCM, Pin 19, con. Black	Data	P.2 #2

MISE EN GARDE / SUPPORT TECHNIQUE

L'information de ce guide est fournie sur la base de représentation (telle quelle) sans aucune garantie de précision et d'exactitude. Il est de la seule responsabilité de l'installateur de vérifier tous les fils et circuit avant de effectuer les connexions. Seule une sonde logique ou un multimètre digital doivent être utilisés. FORTIN Electronic systems n'assume aucune responsabilité de l'exactitude de l'information fournie. L'installation (dans chaque cas) est la responsabilité de l'installateur effectuant le travail. FORTIN Electronic system n'assume aucune responsabilité suite à l'installation, que celle-ci soit bonne ou mauvaise ou de n'importe autre type. Ni le fabricant, ni le distributeur ne se considèrent responsables des dommages causés ou ayant pu être causés, indirectement ou directement, par ce module, excepté le remplacement de ce module en cas de défaut de fabrication. Ce module doit être installé par un technicien qualifié. L'information fournie dans ce guide est une suggestion. Ce guide d'instruction peut faire l'objet de changement sans préavis. Consultez le www.ifar.ca pour voir la plus récente version.

Support Technique:
TEL: 514-255-HELP (4357)
FAX: 514-255-1367
Web: www.ifar.ca

FORTIN
SYSTÈMES ÉLECTRONIQUES