



## ALARM AND REMOTE STARTER CAN BUS INTERFACE KIT



### WIRING / CONNECTION GUIDE

See wiring schematic configuration

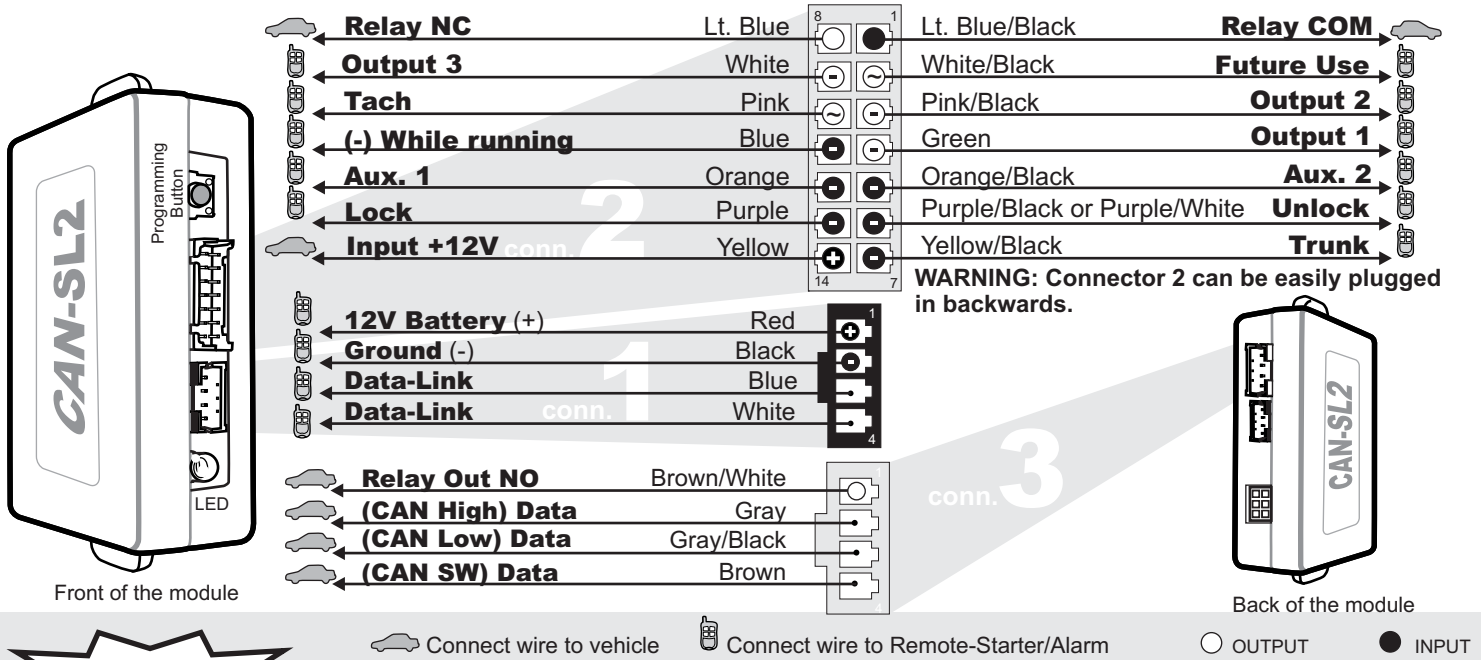

### START HERE

## INSTALLATION AND PROGRAMMING INSTRUCTIONS

- 1 Make the connections of the CAN-SL2 to the vehicle:**

  - 1.A Connector 1 (Black):**  
Determine the type of installation:  
INSTALLATION WITH DATA-LINK (See P.4)  
INSTALLATION WITHOUT DATA-LINK (See P.4)
  - 1.B Connector 2 (White):**  
Make the connections associated with the vehicle in the VEHICLE FIT GUIDE (P.2-3)
  - 1.C Connector 3 (White, located at the back of the module):**  
Make the connections associated with the vehicle in the VEHICLE FIT GUIDE (P.2-3)
- 2 Press** the programming switch while inserting the main wires harness (**CONN 1**) into the CAN-SL2 module. The LED will illuminate to indicate you are in programming mode, release the programming button.
- 3 Connect** the other connectors (**CONN. 2**)  
**WARNING: Connector 2 can be easily plugged in backwards.**
- 4 Connect** the other connectors (**CONN. 3**)

- 5** Turn the key to the "ON" position.
- Once the LED starts to flash rapidly turn the key to the **OFF** position. (GMC vehicle : Start the vehicle)
- The LED will turn off to indicate the module has been programmed.

**The module is now ready for use.** (\*Chrysler, Dodge, Jeep models continue with step 7)
- \* Chrysler/Dodge/Jeep models**

The LED will flash until you **press the OEM remote lock button.**
- The LED will turn off to indicate the module has been programmed.

**The module is now ready for use.**

### TECHNICAL SUPPORT / INFORMATION

Neither the manufacturer or distributor of this module is responsible of damages of any kind indirectly or directly caused by this module, except for the replacement of this module in case of manufacturing defects. This module must be installed by qualified technician. This instruction guide may change without notice. Visit [www.ifar.ca](http://www.ifar.ca) to get latest version.

**Technical support:**  
 TEL: 514-255-HELP (4357)  
 FAX: 514-255-1367  
 Web: [www.ifar.ca](http://www.ifar.ca)

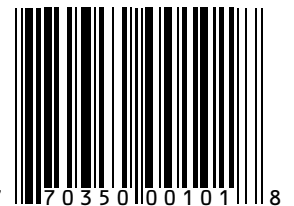





## VEHICLE FIT GUIDE / GUIDE DES VÉHICULES

Volvo	01	02	03	04	05	06	07	08	09	10	A	B	C	D	E	F	G	H	I	J	K	L	M	N	O	P	Q	R	S	T	U
V50																														8	CAN High: White CAN Low: Green
V70																														7	CAN High: White CAN Low: Green
XC70																														7	CAN High: White CAN Low: Green
XC90																														7	CAN High: White CAN Low: Green

This Vehicle Fit Guide may change without notice. Visit [www.ifar.ca](http://www.ifar.ca) to get latest version. Ce Guide des véhicules peut faire l'objet de changement sans préavis. Consultez le [www.ifar.ca](http://www.ifar.ca) pour voir la plus récente version.

\*:IK = Intelli-Key  
\*\* :Ouverture des fenêtres (Window roll down).  
\*\*\* :Schéma de branchement (Wiring schematic configuration)  
\*\*\*\* : See INT-BMW-1 Installation schematic. Voir Schéma d'installation du INT-BMW-1.  
\*\*\*\*\* : Installation schematic coming soon. Schéma d'installation à venir.  
▶ Use PATS-GM2 Utilisez le PATS-GM2

Black: Noir  
Blue: Bleu  
Brown: Brun  
Green: Vert  
Gray: Gris  
Lt: Pâle  
Orange: Orange  
Pink: Rose  
Purple: Mauve  
Red: Rouge  
Tan: Beige  
Yellow: Jaune  
White: Blanc

### INSTALLATION WITH DATA-LINK / INSTALLATION AVEC DATA-LINK

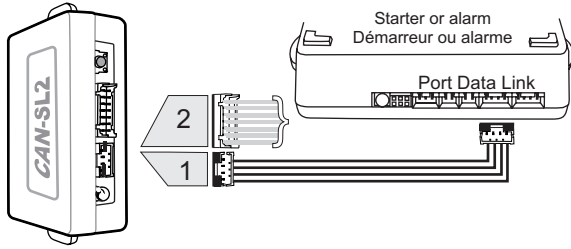

### INSTALLATION WITHOUT DATA-LINK / INSTALLATION SANS DATA-LINK

Cut off one plug of the Data-Link connector, connect the red wire to +12V and the black wire to ground.

Coupez les 4 fils à l'extrémité de l'un des deux connecteurs Data-Link. Connectez le fil rouge au 12V et le fil noir à la masse du véhicule.

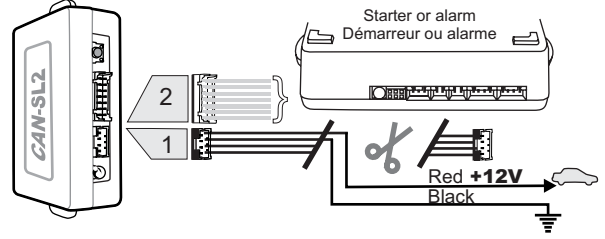

## WIRING SCHEMATIC CONFIGURATION / SCHÉMA DE BRANCHEMENT

### Configuration 1

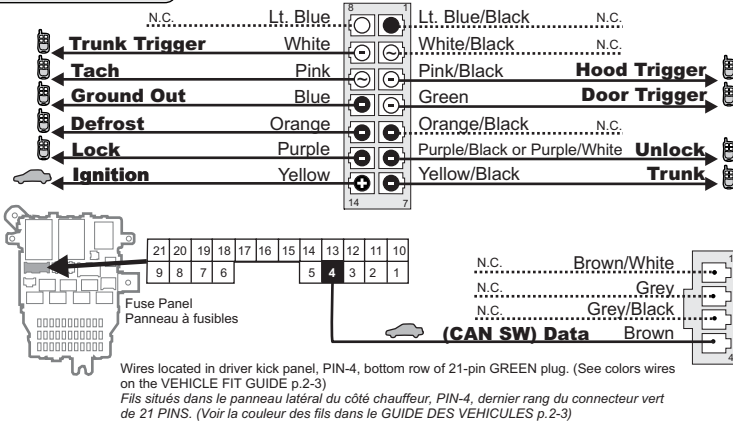

### Configuration 2

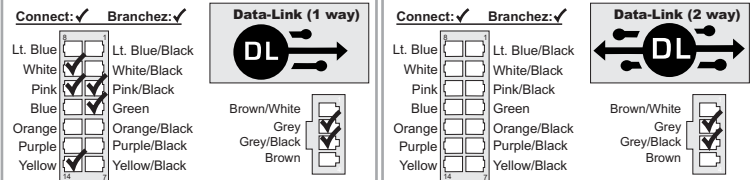
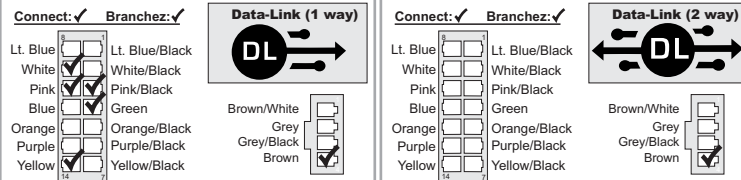
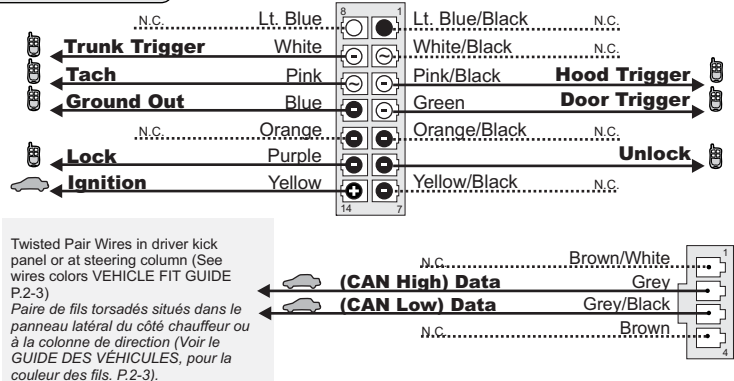

### Configuration 3

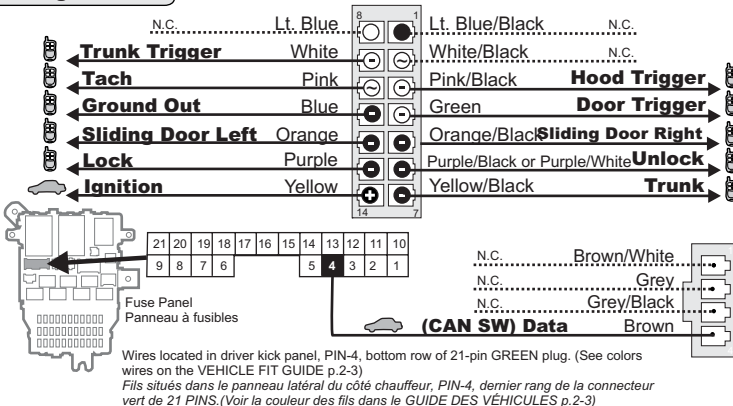

### Configuration 4

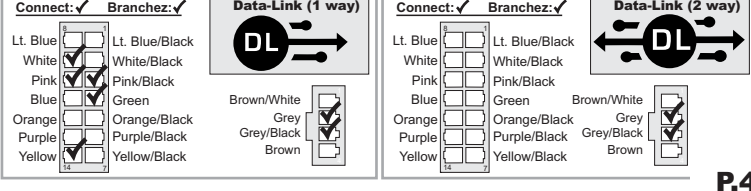
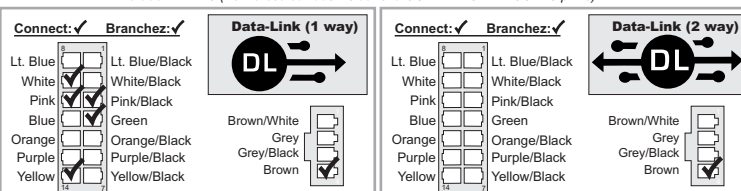
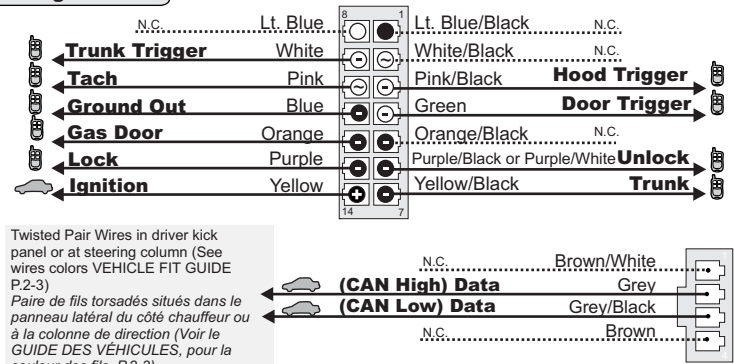

## WIRING SCHEMATIC CONFIGURATION / SCHÉMA DE BRANCHEMENT

**Configuration 5**

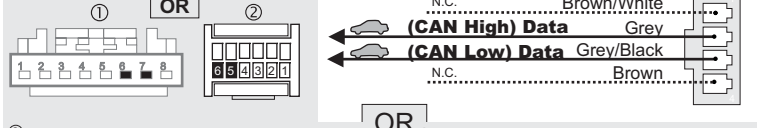
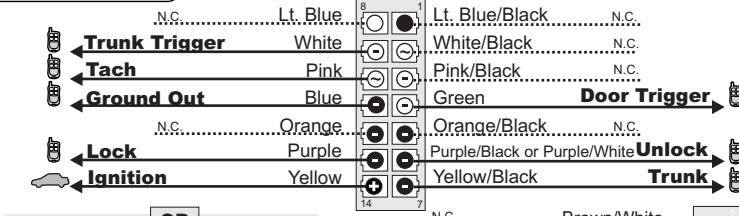

Connect: ✓ Branchez: ✓

**Data-Link (1 way)**

**Data-Link (2 way)**

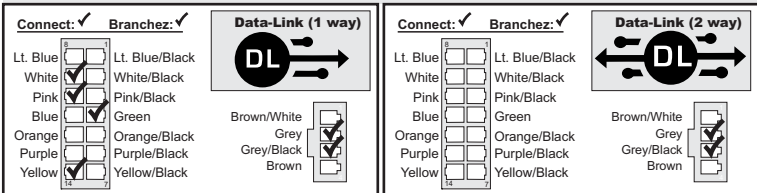

**Configuration 6**

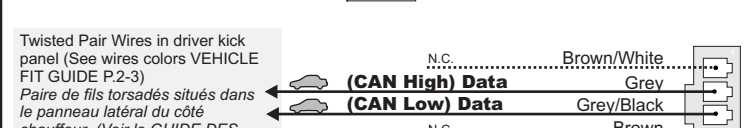
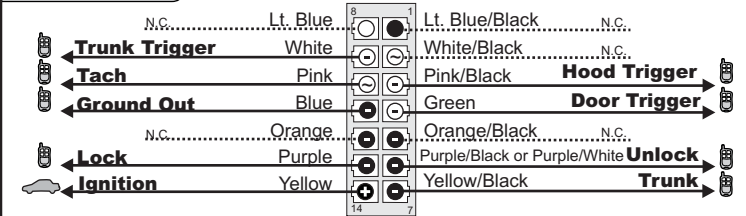

Connect: ✓ Branchez: ✓

**Data-Link (1 way)**

**Data-Link (2 way)**

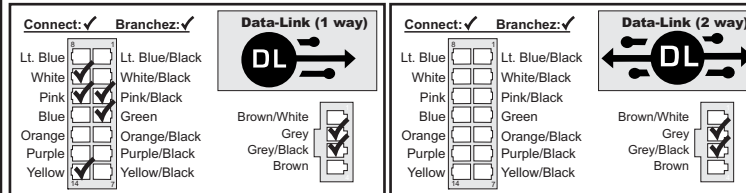

**Configuration 7**

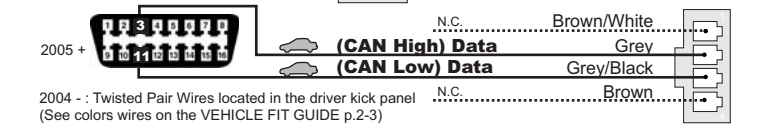
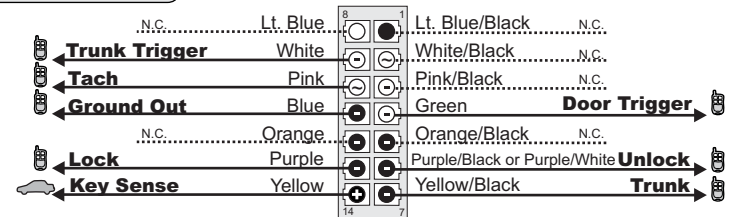

Connect: ✓ Branchez: ✓

**Data-Link (1 way)**

**Data-Link (2 way)**

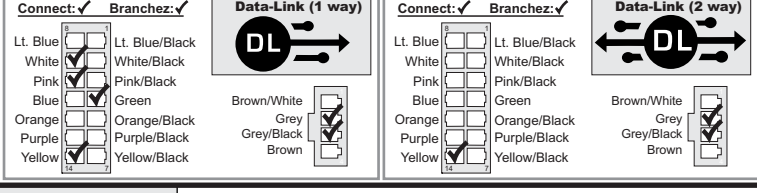

**Configuration 8**

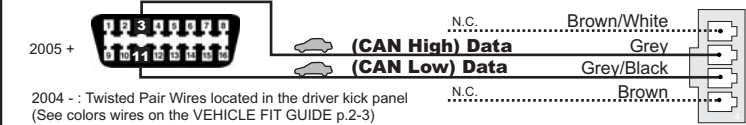
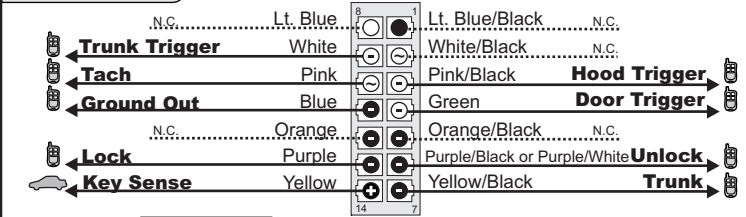

Connect: ✓ Branchez: ✓

**Data-Link (1 way)**

**Data-Link (2 way)**

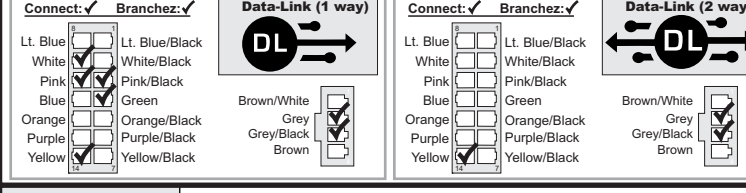

**Configuration 9**

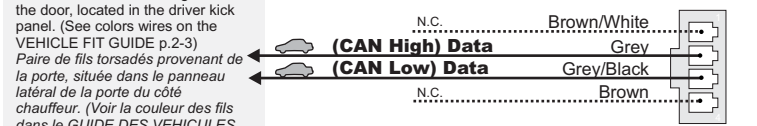
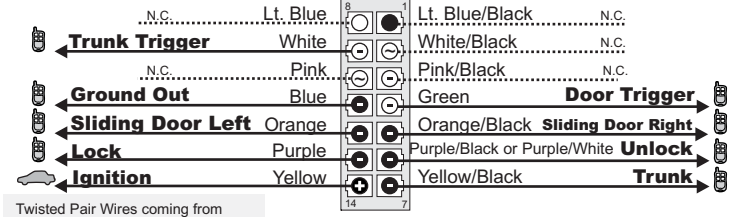

Connect: ✓ Branchez: ✓

**Data-Link (1 way)**

**Data-Link (2 way)**

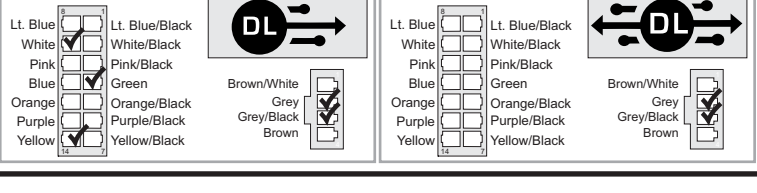

**Configuration 10**

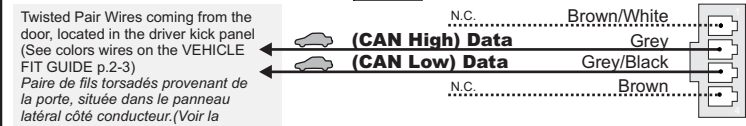
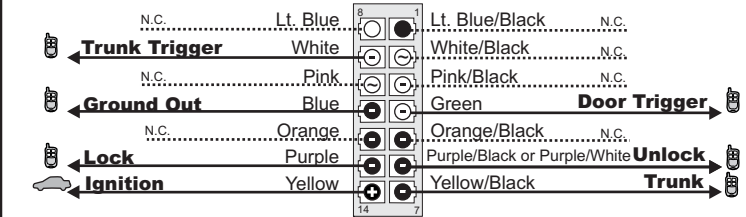

Connect: ✓ Branchez: ✓

**Data-Link (1 way)**

**Data-Link (2 way)**

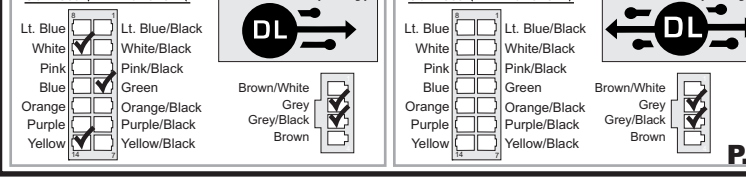

## WIRING SCHEMATIC CONFIGURATION / SCHÉMA DE BRANCHEMENT

### Configuration 11

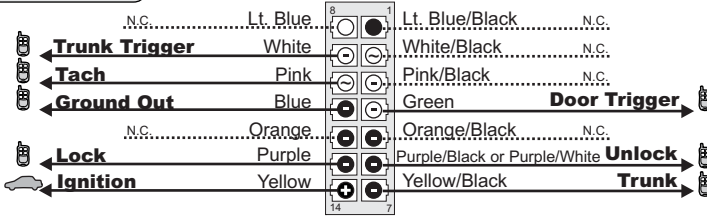

Twisted Pair Wires located under the glove compartment at the BCM. (See colors wires on the VEHICLE FIT GUIDE p.2-3)  
Paire de fils torsadés situés sous le coffre à gant au BCM. (Voir la couleur des fils dans le GUIDE DES VÉHICULES p.2-3)

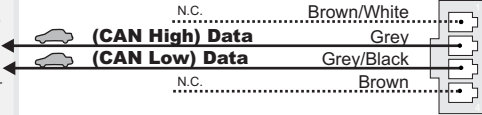

#### Connect: ✓ Branchez: ✓



#### Data-Link (1 way)

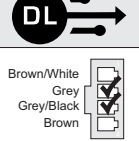

#### Connect: ✓ Branchez: ✓



#### Data-Link (2 way)

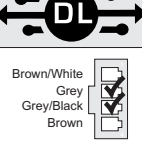

### Configuration 12

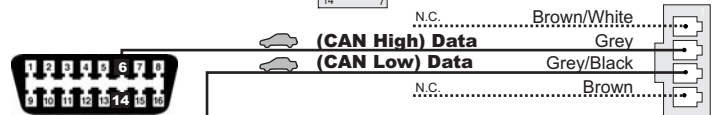
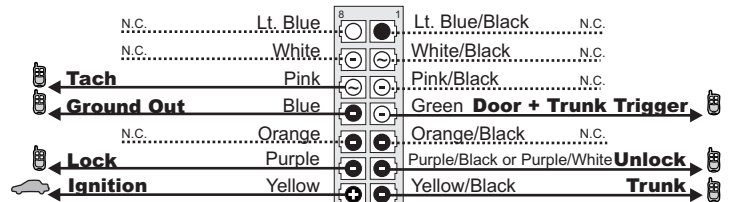

#### Connect: ✓ Branchez: ✓



#### Data-Link (1 way)

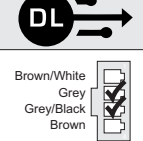

#### Connect: ✓ Branchez: ✓



#### Data-Link (2 way)

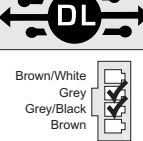

### Configuration 13

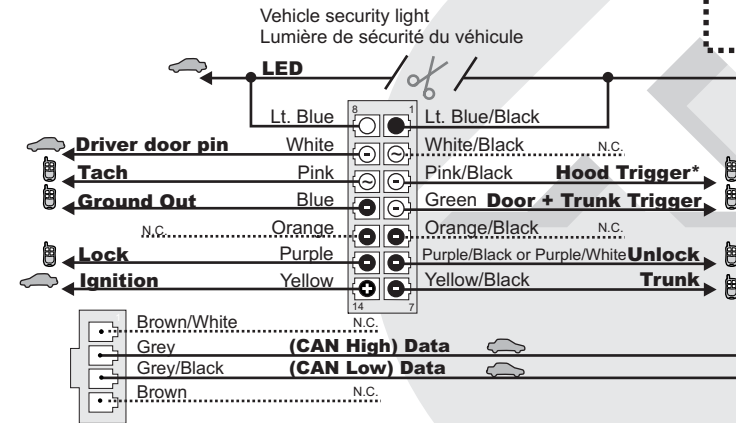

To control OEM Alarm on vehicle (NON INTELLI-KEY vehicles) add the following wires to the empty pins on the BCM.  
Pour contrôler l'alarme d'origine des véhicules NON ÉQUIPÉS DE L'INTELLI-KEY ajoutez des fils dans les espaces vides du BCM.

\* Only if the vehicle is equipped with a hood pin.  
\* Seulement si le véhicule est équipé de la pin de capot.

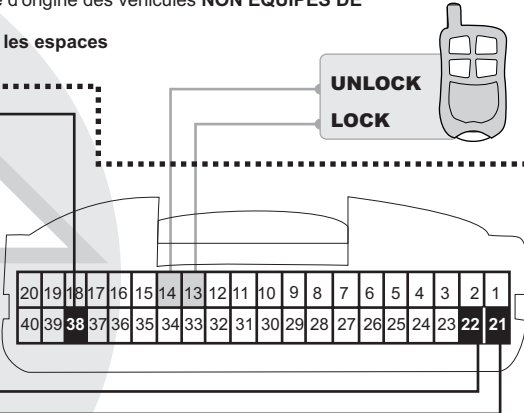

Front view of the BCM connector located on the driver kick panel or above the acceleration pedal. For the Versa vehicle: Connector located behind the glove compartment.  
Vue de face de la prise du BCM situé dans le panneau latéral conducteur ou au-dessus de la pédale d'accélération. Pour les véhicules Versa: Connecteur situé derrière le coffre à gant.

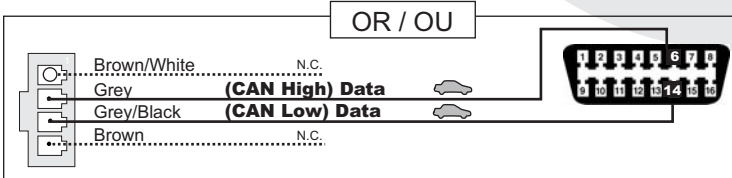

#### Connect: ✓ Branchez: ✓

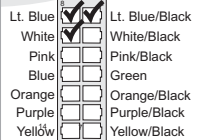

#### Data-Link (2 way)

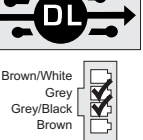

#### Connect: ✓ Branchez: ✓



#### Data-Link (1 way)

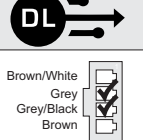

### Configuration 14

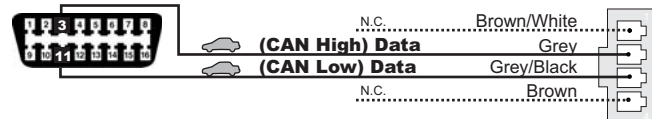
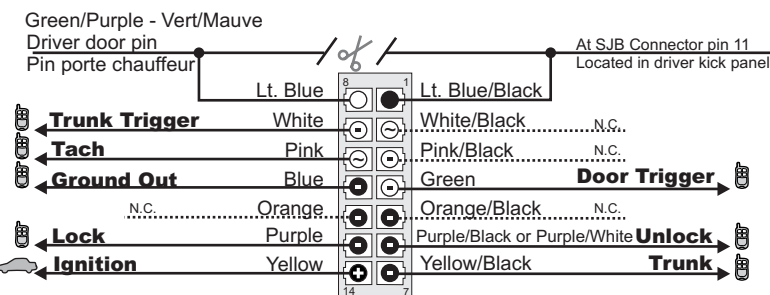

#### Connect: ✓ Branchez: ✓



#### Data-Link (1 way)

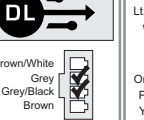

#### Connect: ✓ Branchez: ✓

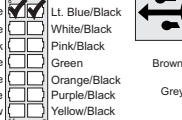

#### Data-Link (2 way)

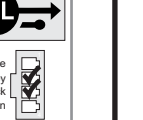

### WIRING SCHEMATIC CONFIGURATION / SCHÉMA DE BRANCHEMENT

#### Configuration 15

Remote-Starter / Démarreur à distance

Connection for Transponder bypass./ Connexion pour le contournement transpondeur.

**WARNING:** All Ignition and accessory wires of the remote starter must be connected at the ignition barrel.

**ATTENTION:** Les fils d'ignition et d'accessoire du démarreur à distance doivent être connectés au barillet d'ignition.

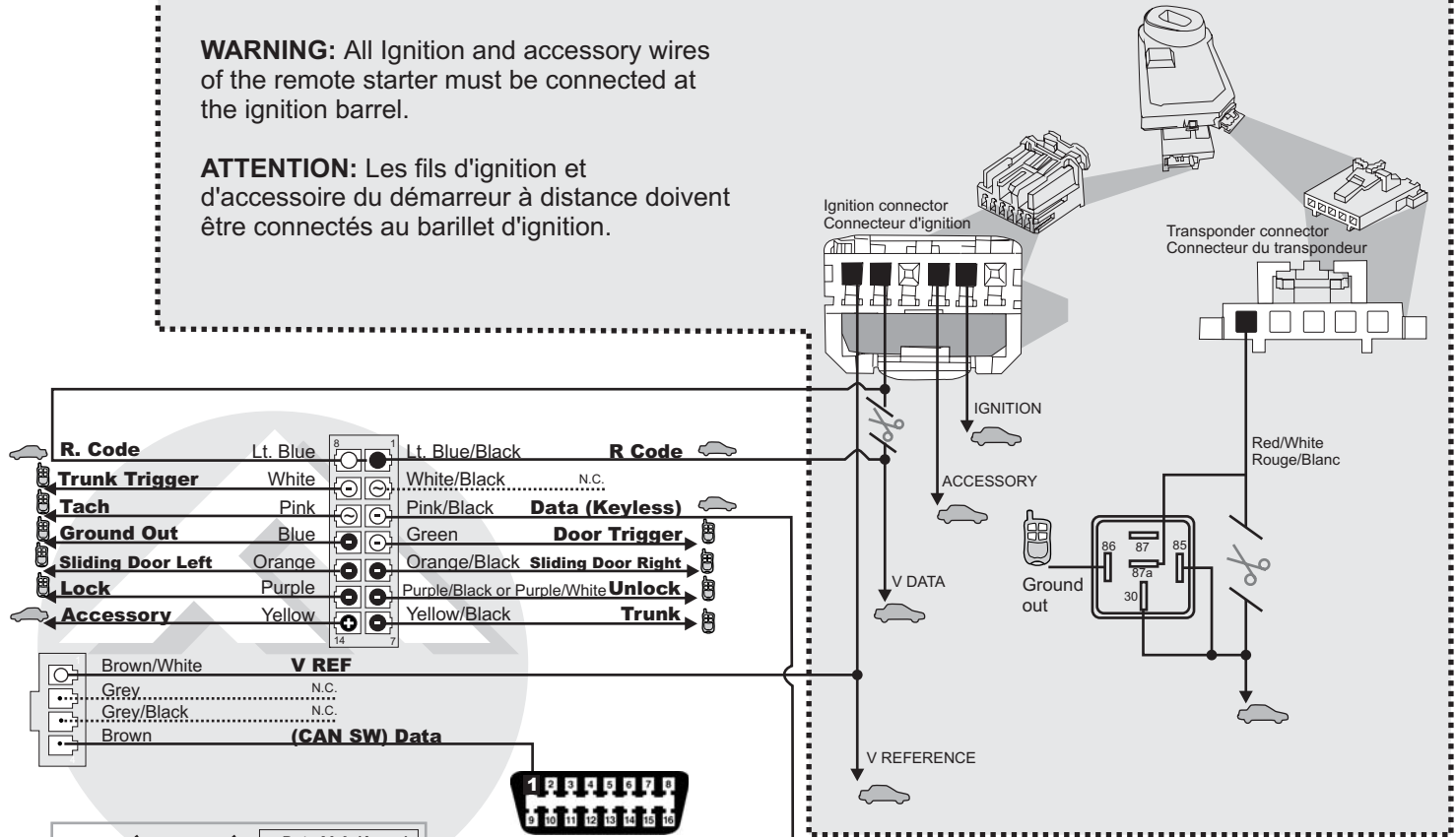

Connect: ✓	Branchez: ✓	Data-Link (1 way)	
Lt. Blue	Lt. Blue/Black		Brown/White
White	White/Black		
Pink	Pink/Black	Grey	Grey/Black
Blue	Green	Grey/Black	Brown
Orange	Orange/Black		
Purple	Purple/Black		
Yellow	Yellow/Black		

Connect: ✓	Branchez: ✓	Data-Link (2 way)	
Lt. Blue	Lt. Blue/Black		Brown/White
White	White/Black		
Pink	Pink/Black	Grey	Grey/Black
Blue	Green	Grey/Black	Brown
Orange	Orange/Black		
Purple	Purple/Black		
Yellow	Yellow/Black		

For OEM door lock control and trunk release  
Pour contrôle du verrouillage des portes et valise.

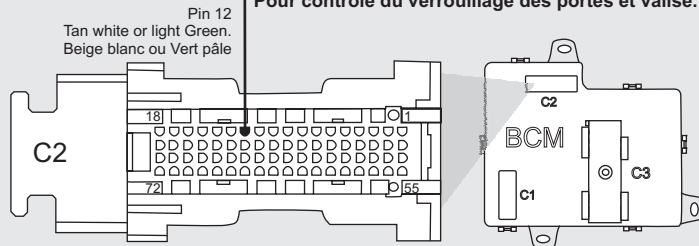

Located on the right side of the center console.  
Situé du côté droit de la console centrale.

Connection needed for vehicles 2006 and older.  
(Not required for vehicles 2007 and newer.)

Effectuez ce branchement pour les véhicules 2006 et moins.  
(sur véhicules 2007 et plus branchement non requis)

Vehicles / Véhicules	Wire colors / Couleur(s) des fils					
	V REFERENCE	V DATA	ACCESSORY	IGNITION	CAN SW	DATA KEY LESS
<b>Chevrolet</b>						
Cobalt	White/Black	White	Brown	Yellow	Green	Tan/White
HHR	White/Black	White	Brown	Yellow	Green	Tan/White
Malibu	White/Black	White	Brown	Pink	Green	Lt Green
<b>Pontiac</b>						
G5	White/Black	White	Brown	Pink	Green	Tan/White
G6	White/Black	White	Brown	Pink	Green	Lt Green
Pursuit	White/Black	White	Brown	Yellow	Green	Tan/White
Solstice	White/Black	White	Brown	Yellow	Green	Tan/White
<b>Saturn</b>						
Aura	White	White/Black	Brown	Pink	Green	Lt Green
Sky	White/Black	White	Brown	Yellow	Green	Tan/White

White: Blanc Black: Noir Blue: Bleu Brown: Brun Green: Vert Gray: Gris Lt: Pâle Orange: Orange Pink: Rose Purple: Mauve Red: Rouge Tan: Beige Yellow: Jaune

## WIRING SCHEMATIC CONFIGURATION / SCHÉMA DE BRANCHEMENT

### Configuration 16

#### Remote-Starter / Démarreur à distance

Connection for Transponder bypass. / Connexion pour le contournement transpondeur.

**WARNING:** All Ignition and accessory wires of the remote starter must be connected at the ignition barrel.  
**ATTENTION:** Les fils d'ignition et d'accessoire du démarreur à distance doivent être connectés au barillet d'ignition.

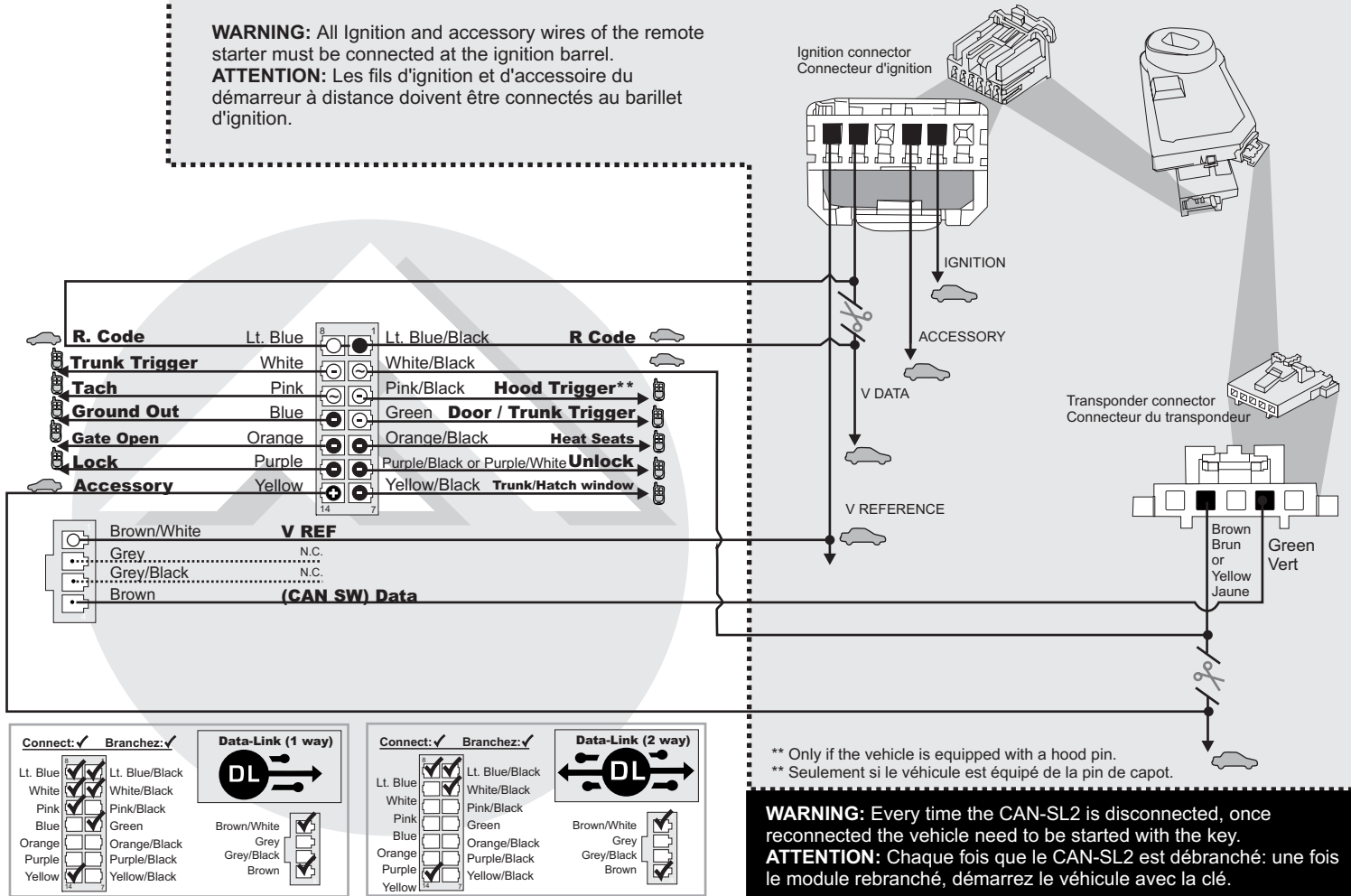

Vehicles / Véhicules	Wire colors / Couleur(s) des fils					
	V REFERENCE	V DATA	ACCESSORY	IGNITION	CAN SW	DATA KEY LESS
<b>Buick</b>						
Enclave	White	White/Black	Brown	Pink	Green	N.A.
Lucerne	White/Black	White	Brown	Pink	Green	N.A.
<b>Cadillac</b>						
CTS	White/Black	White	Brown	Pink	Green	N.A.
DTS	White/Black	White	Brown	Pink	Green	N.A.
Escalade	White	Pink/Black	Yellow	Pink	Green	N.A.
SRX	White/Black	White	Brown	Pink	Green	N.A.
STS					Green	N.A.
<b>Chevrolet</b>						
Avalanche	White	Pink/Black	Yellow	Pink	Green	N.A.
CK Pickup	White	Pink/Black	Yellow	Pink	Green	N.A.
Equinox	White/Black	White	Brown	Pink	Green	N.A.
Express	White	Pink	Brown	Pink	Green	N.A.
Impala	White/Black	White	Brown	Pink	Green	N.A.
Monte Carlo	White/Black	White	Brown	Pink	Green	N.A.
Silverado	White	Pink/Black	Yellow	Pink	Green	N.A.
Tahoe	White	Pink/Black	Yellow	Pink	Green	N.A.
Suburban	White	Pink/Black	Yellow	Pink	Green	N.A.
<b>GMC</b>						
Acadia	White/Black	White	Brown	Pink	Green	N.A.
Savana	White	White/Black	Yellow	Pink	Green	N.A.
Sierra	White	Pink/Black	Yellow	Pink	Green	N.A.
Suburban	White	Pink/Black	Yellow	Pink	Green	N.A.
Yukon	White	Pink/Black	Yellow	Pink	Green	N.A.
<b>Saturn</b>						
Outlook	White	White/Black	Brown	Pink	Green	N.A.
Vue	White	White/Black	Yellow	Pink	Green	N.A.
<b>Pontiac</b>						
G8	White/Black	White	Brown	Pink	Green	N.A.
Torrent	White/Black	White	Brown	Pink	Green	N.A.
<b>Suzuki</b>						
XL7	White/Black	White	Brown	Pink	Green	N.A.

## WIRING SCHEMATIC CONFIGURATION / SCHÉMA DE BRANCHEMENT

### Configuration 17

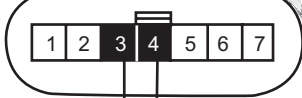
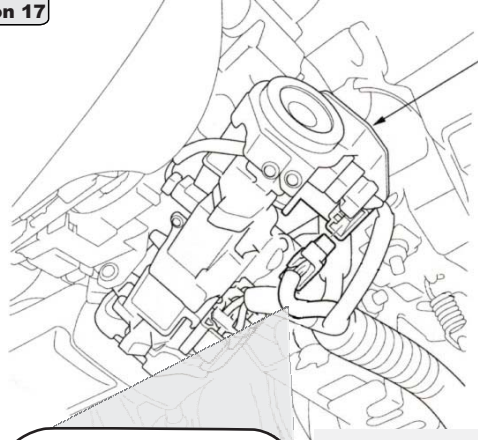

Wires located at steering column immobilizer control unit  
Fils situés à la colonne de direction au module de contrôle de la clé à puce

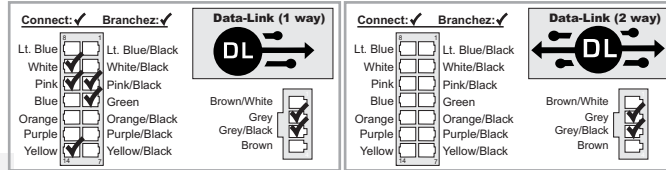
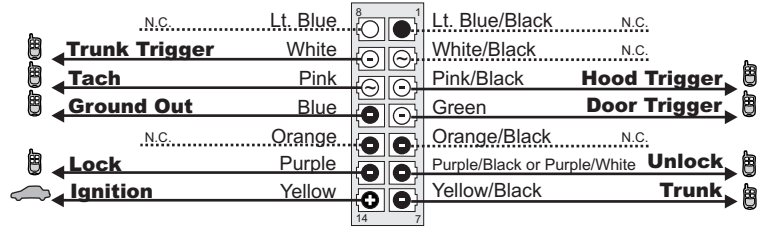

### Configuration 18

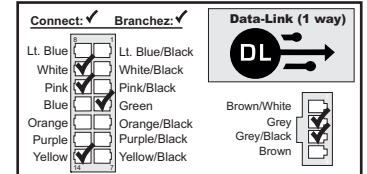
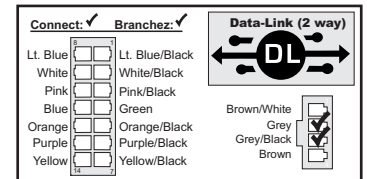
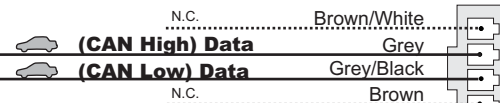
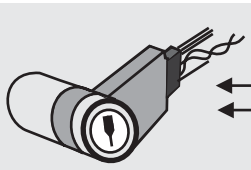
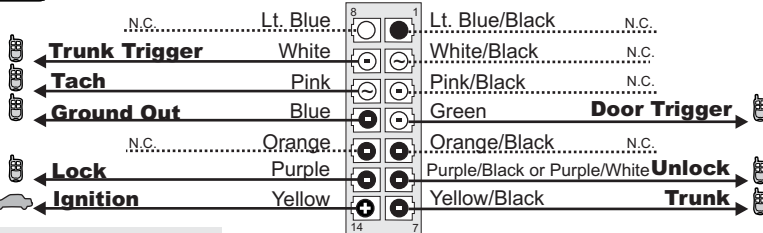

Twisted Pair Wires located at steering column or near cluster (See colors wires on the VEHICLE FIT GUIDE p.2-3)  
Paire de fils torsadés situés dans le harnais de la colonne de direction ou sous le tableau de bord. (Voir la couleur des fils dans le GUIDE DES VÉHICULES p.2-3)

### Configuration 19

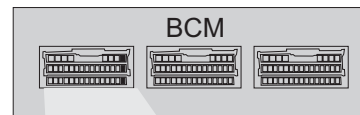
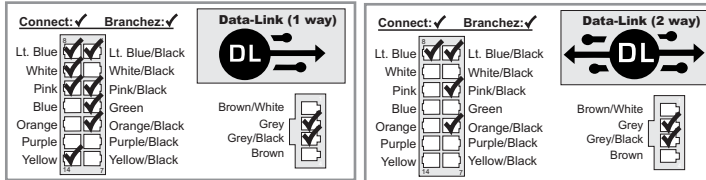

BCM located directly below the steering column.  
BCM situés directement sous la colonne de direction

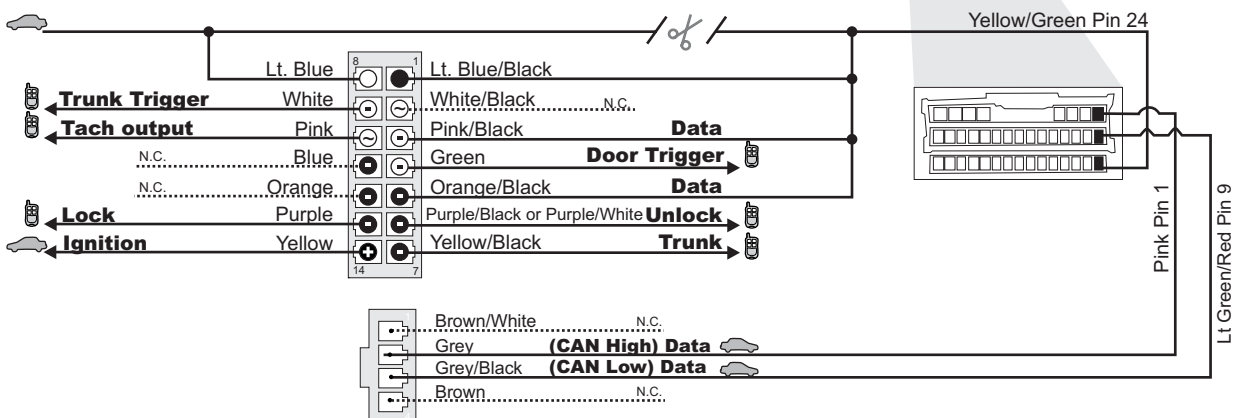



### WIRING SCHEMATIC CONFIGURATION / SCHÉMA DE BRANCHEMENT

#### Configuration 20



**REMOTE STARTER**  
The remote starters starter output is not required.

**DÉMARREUR À DISTANCE**  
La sortie Start du démarreur à distance n'est pas requise pour ce véhicule.

Ignition  
Accessory

Make 10 loops with a 22 to 26 gauge wire around the factory key.  
Faire 10 tours autour de la clé d'origine avec un fil de calibre 22 à 26.

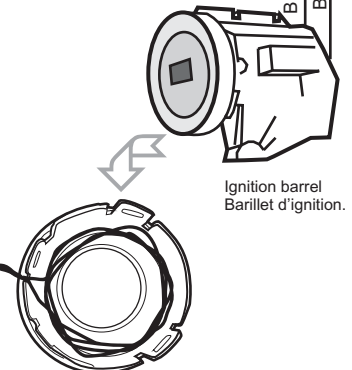
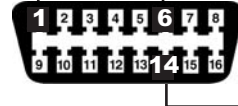
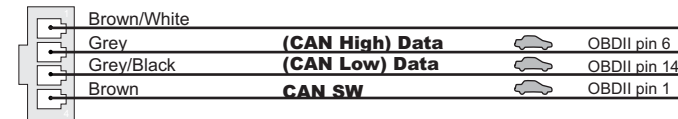
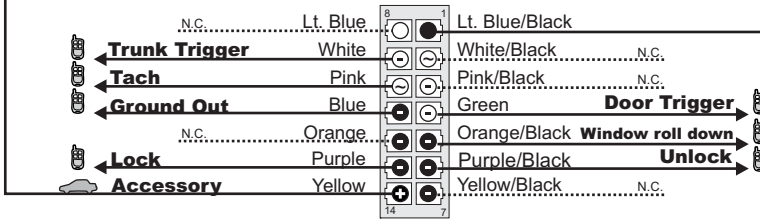

- 1 Remove the plastic cover of the Ignition barrel  
Retirez le couvert de plastique du barillet d'ignition.
- 2 Wrap the wire around the inside of the plastic ring 4 times.  
Faire a 4 tours à l'intérieur de l'anneau de plastique avec le fil.

<p><b>Connect: ✓ Branchez: ✓</b></p> <table border="1"> <tr><td>Lt. Blue</td><td><input type="checkbox"/></td></tr> <tr><td>White</td><td><input checked="" type="checkbox"/></td></tr> <tr><td>Pink</td><td><input checked="" type="checkbox"/></td></tr> <tr><td>Blue</td><td><input checked="" type="checkbox"/></td></tr> <tr><td>Orange</td><td><input type="checkbox"/></td></tr> <tr><td>Purple</td><td><input type="checkbox"/></td></tr> <tr><td>Yellow</td><td><input checked="" type="checkbox"/></td></tr> </table>	Lt. Blue	<input type="checkbox"/>	White	<input checked="" type="checkbox"/>	Pink	<input checked="" type="checkbox"/>	Blue	<input checked="" type="checkbox"/>	Orange	<input type="checkbox"/>	Purple	<input type="checkbox"/>	Yellow	<input checked="" type="checkbox"/>	<p><b>Connect: ✓ Branchez: ✓</b></p> <table border="1"> <tr><td>Lt. Blue/Black</td><td><input type="checkbox"/></td></tr> <tr><td>White/Black</td><td><input type="checkbox"/></td></tr> <tr><td>Pink/Black</td><td><input type="checkbox"/></td></tr> <tr><td>Green</td><td><input type="checkbox"/></td></tr> <tr><td>Orange/Black</td><td><input type="checkbox"/></td></tr> <tr><td>Purple/Black</td><input type="checkbox"/></tr></table>	Lt. Blue/Black	<input type="checkbox"/>	White/Black	<input type="checkbox"/>	Pink/Black	<input type="checkbox"/>	Green	<input type="checkbox"/>	Orange/Black	<input type="checkbox"/>	Purple/Black
Lt. Blue	<input type="checkbox"/>																									
White	<input checked="" type="checkbox"/>																									
Pink	<input checked="" type="checkbox"/>																									
Blue	<input checked="" type="checkbox"/>																									
Orange	<input type="checkbox"/>																									
Purple	<input type="checkbox"/>																									
Yellow	<input checked="" type="checkbox"/>																									
Lt. Blue/Black	<input type="checkbox"/>																									
White/Black	<input type="checkbox"/>																									
Pink/Black	<input type="checkbox"/>																									
Green	<input type="checkbox"/>																									
Orange/Black	<input type="checkbox"/>																									
Purple/Black																										
Yellow/Black	<input type="checkbox"/>																									

 **Data-Link (1 way)**  **DL** →   |             |                                     | |-------------|-------------------------------------| | Brown/White | <input checked="" type="checkbox"/> | | Grey        | <input checked="" type="checkbox"/> | | Grey/Black  | <input checked="" type="checkbox"/> | | Brown       | <input checked="" type="checkbox"/> | | **Connect: ✓ Branchez: ✓**   |          |                                     | |----------|-------------------------------------| | Lt. Blue | <input checked="" type="checkbox"/> | | White    | <input type="checkbox"/>            | | Pink     | <input type="checkbox"/>            | | Blue     | <input type="checkbox"/>            | | Orange   | <input type="checkbox"/>            | | Purple   | <input type="checkbox"/>            | | Yellow   | <input checked="" type="checkbox"/> | | **Connect: ✓ Branchez: ✓**   |                |                          | |----------------|--------------------------| | Lt. Blue/Black | <input type="checkbox"/> | | White/Black    | <input type="checkbox"/> | | Pink/Black     | <input type="checkbox"/> | | Green          | <input type="checkbox"/> | | Orange/Black   | <input type="checkbox"/> | | Purple/Black   | <input type="checkbox"/> | | Yellow/Black   | <input type="checkbox"/> | | **Data-Link (2 way)**  ← **DL** →   |             |                                     | |-------------|-------------------------------------| | Brown/White | <input checked="" type="checkbox"/> | | Grey        | <input checked="" type="checkbox"/> | | Grey/Black  | <input checked="" type="checkbox"/> | | Brown       | <input checked="" type="checkbox"/> | |



## MODULE D'INTERFACE CAN BUS POUR ALARME ET DÉMARREUR À DISTANCE



### CÂBLAGE / GUIDE DE CONNEXION

Voir SCHÉMA DE BRANCHEMENT

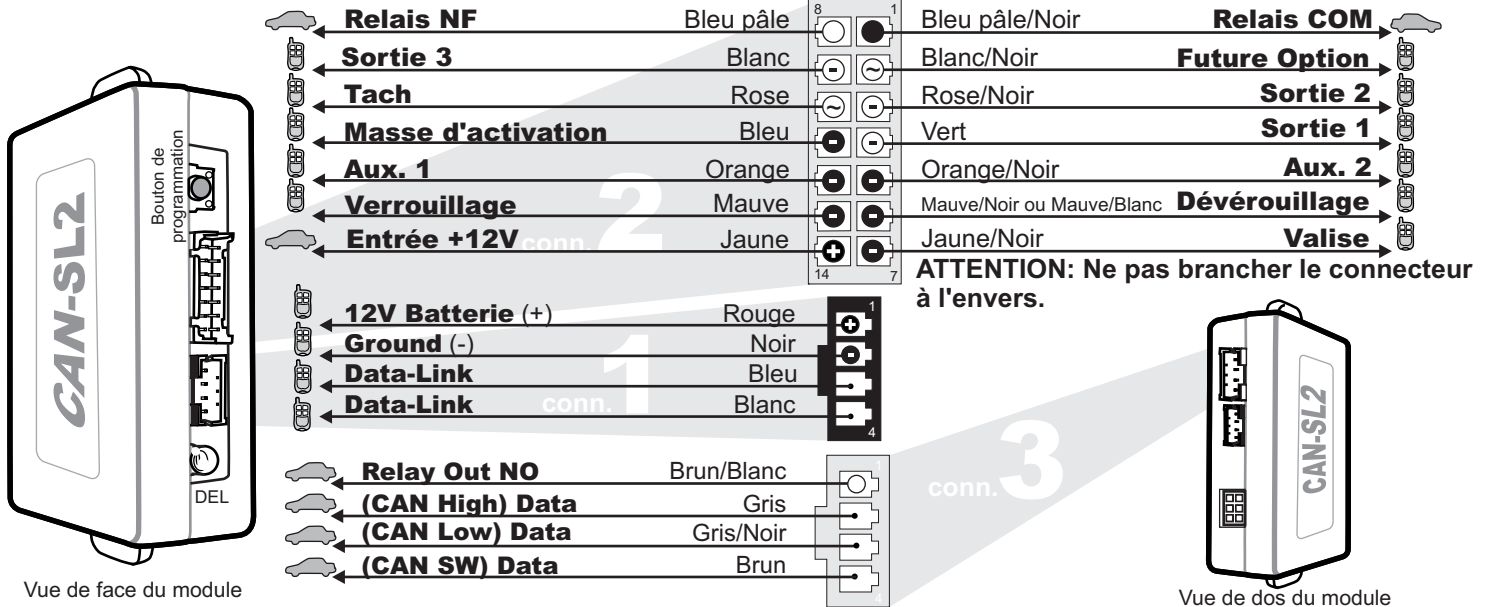

Vue de face du module

Vue de dos du module

Branchement du filage au démarreur à distance/Alarme Branchement du filage au véhicule  SORTIE  ENTRÉE

### COMMENCEZ ICI

## INSTRUCTIONS D'INSTALLATION ET DE PROGRAMMATION

Effectuez les connexions du CAN-SL2 au véhicule:

**1 1.A**  
**Connecteur 1 (Noir):**  
Déterminez le type d'installation (Data-Link ou non Data-Link)  
Pour l'installation DATA-LINK assurez vous de la présence du connecteur DATA-LINK sur le démarreur. (Voir INSTALLATION AVEC DATA-LINK (P.4)).  
Pour installation non Data-Link voir INSTALLATION SANS DATA-LINK (P.4).

**1.B**  
**Connecteur 2 (Blanc):**  
Déterminez le type de branchement selon votre véhicule  
(Voir GUIDE DES VOITURES, P.2-3)

**1.C**  
**Connecteur 3 (Blanc, situé au dos du module):**  
Déterminez le type de branchement selon votre véhicule  
(Voir GUIDE DES VOITURES, P.2-3)

**2**  
**Maintenez le bouton de programmation enfoncé** en insérant le **connecteur 1** dans le CAN-SL2.  
Le DEL s'allume pour indiquer le début de la programmation, **relâchez le bouton de programmation.**

Branchez le connecteur 2 (CONN. 2)

**3**  
**ATTENTION: Ne pas brancher le connecteur à l'envers.**

**4**  
Branchez le connecteur 3 (CONN. 3)

**5**  
Tournez la clef en position **ignition**.

**6**  
Lorsque le DEL clignote rapidement, **tournez la clef en position OFF.** (Sauf véhicules GMC: démarrez le véhicule).  
**Le DEL s'éteint pour indiquer que le module est programmé.**

(\* Sauf pour les véhicules Chrysler, Dodge, Jeep, poursuivre à l'étape 7)

### \* Chrysler/Dodge/Jeep

**7**  
Le DEL clignotera jusqu'à ce que vous pressiez le bouton Verrouillage (Lock) de la télécommande d'origine du véhicule.  
**Le DEL s'éteint pour indiquer que le module est programmé.**

## INFORMATIONS / SUPPORT TECHNIQUE

Ni le fabricant, ni le distributeur ne se considèrent responsables des dommages causés ou ayant pu être causés, indirectement ou directement, par ce module, excepté le remplacement de ce module en cas de défectuosité de fabrication. Ce module doit être installé par un technicien qualifié. Ce guide d'instruction peut faire l'objet de changement sans préavis. Consultez le [www.ifar.ca](http://www.ifar.ca) pour voir la plus récente version.

**Support Technique:**  
TEL: 514-255-HELP (4357)  
FAX: 514-255-1367  
Web: [www.ifar.ca](http://www.ifar.ca)

