



Ford Heavy Truck 2000-2003



KEY-OVERRIDE-ALL

Made in Canada Rev. A - 02 / 07 / 2008
Web site: <http://www.ifar.ca>

ENCRYPTED TRANSPONDER BYPASS MODULE (Self Learning)

LED Module Diagnostics :
On: Activated.
OFF: Not activated.
Flash: Not programmed.

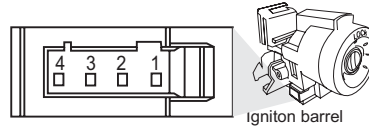
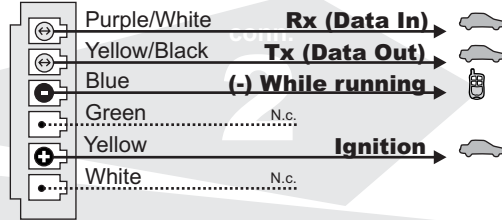
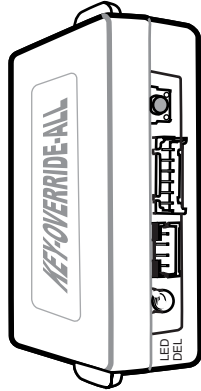

PIN #	DESCRIPTION
1	IGNITION +12V (N.C.)
2	GROUND (N.C.)
3	TX (Data)
4	RX (Data)

SEE www.ifar.ca (KEY-OVERRIDE-SL2 INSTALLATION SUPPLEMENT) FOR VEHICLE WIRE COLORS

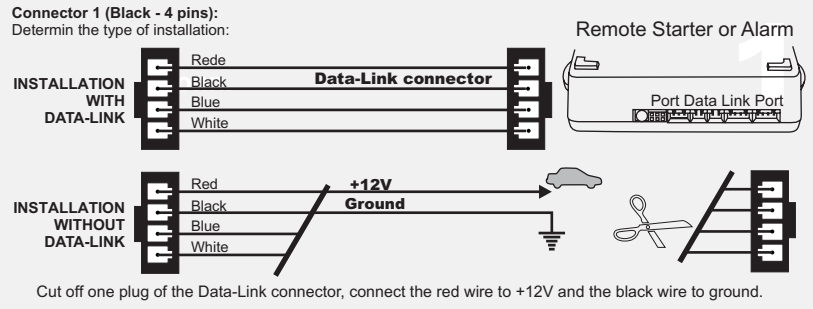

Connector 4 (White - 4 pins):
Connect with the **FLASH LINK UPDATER** for web update.

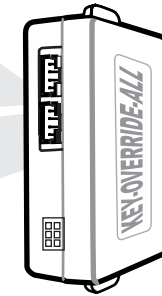

Back view of the module

🔌 Connect wire to Remote-Starter/Alarm 🚗 Connect wire to vehicle

○ OUTPUT ● INPUT

1 **Make the connections to the vehicle:**

1.A **Connector 1 (Black):**
Determine the type of installation:
- **INSTALLATION WITH DATA-LINK**
- **INSTALLATION WITHOUT DATA-LINK**

1.B **Connector 2 (White):** Make the connections

PROGRAMMATION Vehicle equipped with SMART KEY



2 Keep programming button pressed while inserting **connector 1**.

3 Insert **connector 2**.
Release the programming button when the LED turns ON. If the LED is flashing at this point the module is already Programmed and can't be programmed again. (To prevent malicious use this module can be programmed in only one vehicle.)

4 Insert the first functional key into the ignition barrel and turn the ignition ON.

5 When the security light turns OFF, turn the key to the OFF position and remove the first key from the barrel.

You have 5 seconds to complete the following procedure

6 Insert the second functional key into the ignition barrel and turn the ignition ON.

7 When the **dash board security light** turns OFF, turn the key to the **OFF** position and remove the second key from the barrel.

8.a **You have 10 seconds to complete one of the following procedures**

For MANUAL Transmission:

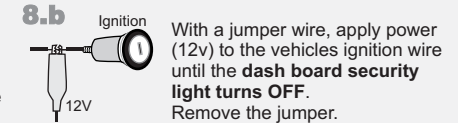
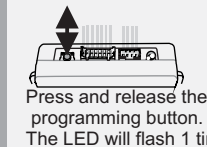

For AUTOMATIC Transmission:



9 **If the LED flashes 10 times, the module is programmed.**
If the LED turns ON, repeat from step 1.



Technical support:
TEL: 514-255-HELP (4357)
FAX: 514-255-1367
Web: www.ifar.ca

Neither the manufacturer or distributor of this module is responsible of damages of any kind indirectly or directly caused by this module, except for the replacement of this module in case of manufacturing defects. This module must be install by qualified technician. This instruction guide may change without notice. Visit www.ifar.ca to get latest version.



Ford Heavy Truck 2000-2003



KEY-OVERRIDE-ALL

Fabriqu  au Canada Rev. A - 02 / 07 / 2008
Site internet <http://www.ifar.ca>

MODULE DE CONTOURNEMENT DE TRANSPONDER ENCRYPT  (Auto-apprentissage)

Diagnostic du DEL du module
Allum : Le module est activ .
 teint: Le module n'est pas activ .
Flash: Le module n'est pas programm .

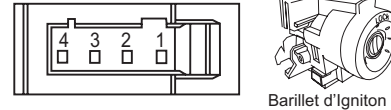
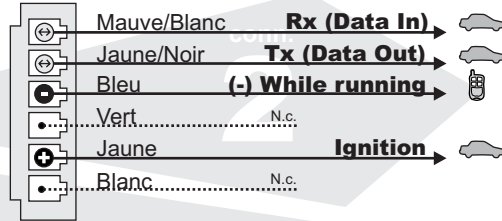
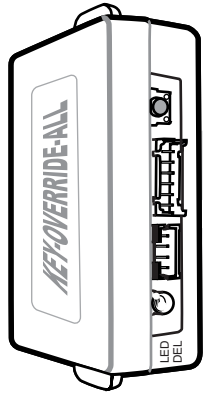

Barillet d'ignition

PIN #	DESCRIPTION
1	IGNITION +12V (N.C.)
2	GROUND (N.C.)
3	TX (Data)
4	RX (Data)

VOIR www.ifar.ca (KEY-OVERRIDE-SL2 SUPPL MENT D'INSTALLATION) POUR LES COULEURS DE FILS DES CONNECTEURS.

Connecteur 1 (Noir - 4 pins):
D terminez le type d'installation:

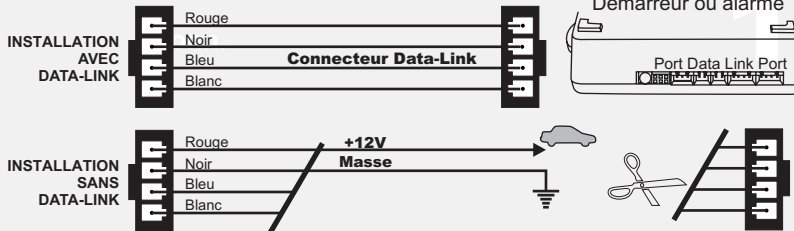

Coupez les 4 fils   l'extr mit  de l'un des deux connecteurs Data-Link. Connectez le fil rouge au 12V et le fil noir   la masse du v hicule.

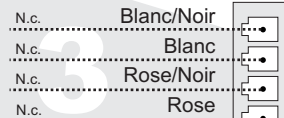

Connecteur 4 (Blanc - 4 pins):
Connectez avec le **FLASH LINK UPDATER** pour les mises   jour par internet.

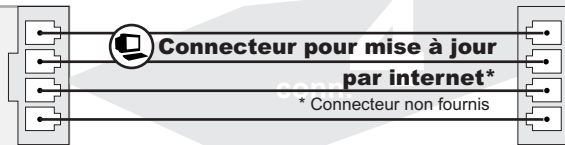

Vue de dos du module

Branchement du filage au d marreur   distance/Alarme Branchement du filage au v hicule SORTIE ENTR E

1 **Effectuez les connexions au v hicule:**
Connecteur 1 (Noir):
 D terminez le type d'installation:
 - INSTALLATION DATA-LINK
 - INSTALLATION NON DATA-LINK

1.B **Connecteur 2 (Blanc):**
 Effectuez les branchements.

PROGRAMMATION V hicule  quip  d'une cl  INTELLIGENTE

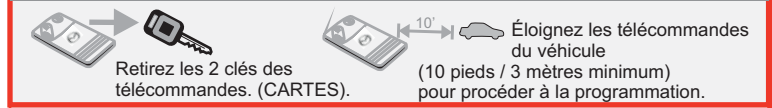

2 Maintenez le bouton de programmation enfonc . Ins rez le **connecteur 1** dans le module.

3 Ins rez le **connecteur 2** dans le module. Lorsque le DEL s'allume, rel chez le bouton de programmation. Si la DEL clignote alors le module a d j   t  programm  sur un v hicule et ne peut  tre programm    nouveau. (Dans le but de pr venir toute utilisation malicieuse, ce module peut  tre programm  dans seulement (1) un v hicule.)

4 Ins rez la cl  fonctionnelle #1 dans le barillet et tournez la cl    la position IGNITION.

5 Lorsque la lumi re s curit  du tableau de bord s' teint, tournez la cl    la position ARR T (OFF) et retirez la cl  du barillet.

Vous avez 5 secondes pour compl ter la proc dure suivante:

6 Ins rez la cl  fonctionnelle #2 dans le barillet et tournez la cl    la position IGNITION.

7 Lorsque la lumi re s curit  du tableau de bord s' teint, tournez la cl    la position ARR T (OFF) et retirez la cl  du barillet.

Vous avez 10 secondes pour compl ter l'une des deux proc dures suivantes:

Pour Transmission MANUELLE:

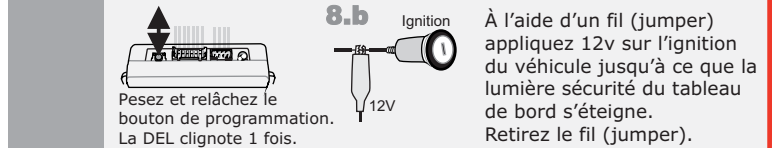

Pour Transmission AUTOMATIQUE



9 **Le DEL clignote 10 fois le MODULE est programm .**
 Si la DEL reste allum e vous devez recommencer la programmation   l' tape 1. Le MODULE n'est pas programm .



Support Technique:
TEL: 514-255-HELP (4357)
FAX: 514-255-1367
Site internet: www.ifar.ca

Ni le manufacturier, ni le distributeur ne se consid rent responsables des dommages caus s ou ayant pu  tre caus s, indirectement ou directement, par ce module, except  le remplacement de ce module en cas de d fectuosit  de fabrication. Ce module doit  tre install  par un technicien qualifi . Ce guide d'installation peut faire l'objet de changement sans pr avis. Consultez le www.ifar.ca pour voir la plus r cente version.