



ALARM AND REMOTE STARTER CAN BUS INTERFACE KIT



WIRING / CONNECTION GUIDE

See wiring schematic configuration

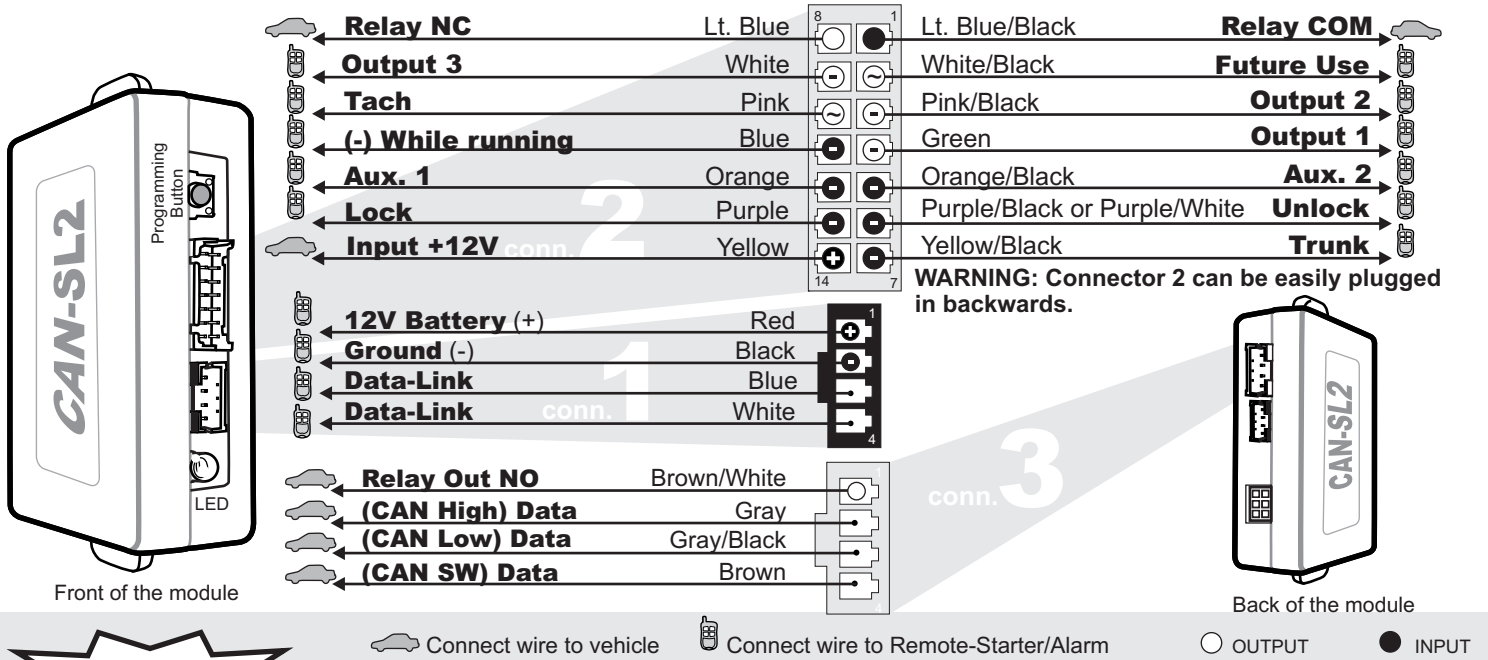

START HERE

INSTALLATION AND PROGRAMMING INSTRUCTIONS

- 1 Make the connections of the CAN-SL2 to the vehicle:**

 - 1.A Connector 1 (Black):**
Determine the type of installation:
INSTALLATION WITH DATA-LINK (See P.4)
INSTALLATION WITHOUT DATA-LINK (See P.4)
 - 1.B Connector 2 (White):**
Make the connections associated with the vehicle in the VEHICLE FIT GUIDE (P.2-3)
 - 1.C Connector 3 (White, located at the back of the module):**
Make the connections associated with the vehicle in the VEHICLE FIT GUIDE (P.2-3)
- 2 Press** the programming switch while inserting the main wires harness (**CONN 1**) into the CAN-SL2 module. The LED will illuminate to indicate you are in programming mode, release the programming button.
- 3 Connect** the other connectors (**CONN. 2**)
WARNING: Connector 2 can be easily plugged in backwards.
- 4 Connect** the other connectors (**CONN. 3**)

- 5** Turn the key to the "ON" position.
- Once the LED starts to flash rapidly turn the key to the **OFF** position. (GMC vehicle : Start the vehicle)
- The LED will turn off to indicate the module has been programmed.

The module is now ready for use. (*Chrysler, Dodge, Jeep models continue with step 7)
- * Chrysler/Dodge/Jeep models**

The LED will flash until you **press the OEM remote lock button.**

The LED will turn off to indicate the module has been programmed.

The module is now ready for use.

TECHNICAL SUPPORT / INFORMATION

Neither the manufacturer or distributor of this module is responsible of damages of any kind indirectly or directly caused by this module, except for the replacement of this module in case of manufacturing defects. This module must be installed by qualified technician. This instruction guide may change without notice. Visit www.ifar.ca to get latest version.

Technical support:
 TEL: 514-255-HELP (4357)
 FAX: 514-255-1367
 Web: www.ifar.ca

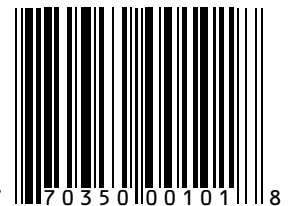



VEHICLE FIT GUIDE / GUIDE DES VÉHICULES

Vehicles Véhicules	Years Années	Fonctionnel if equipped Fonctionnelle si le véhicule en est équipé.																Config. Schéma de câblage	Hatch	Vehicles Data Véhicules Données de couleur de la voiture de couleur									
		Verrouillage	Déverrouillage	Aménagement	Désaménagement	Disarm	Télé	Tach	Système de démarrage	Système de démarrage	Diagnostique	Système de la TUNING	Système de la TUNING	Hubcap	Hubcap	Radié Off	Transpondeur				Passelock	Passelock PK's	Stitching	Stitching	Déglacage	Déglacage	Chauffage	Chauffage	Capteur
Jeep	01 02 03 04 05 06 07 08 09 10	A	B	C	D	E	F	G	H	I	J	K	L	M	N	O	P	Q	R	S	T	U							
Cherokee																						5	CAN High: White/Orange CAN Low: White						
Commander																						5	CAN High: White/Orange CAN Low: White						
Compass																						5	CAN High: White/Orange CAN Low: White/Pink						
Grand Cherokee																						5	CAN High: White/Orange CAN Low: White						
Patriot																						5	CAN High: White/Orange CAN Low: White/Pink						
Liberty																						5	CAN High: White/Green CAN Low: White/Blue						
Wrangler																						5	CAN High: White/Green CAN Low: White/Blue						
Kia	01 02 03 04 05 06 07 08 09 10	A	B	C	D	E	F	G	H	I	J	K	L	M	N	O	P	Q	R	S	T	U							
Amanti																						10	CAN High: Brown CAN Low: White						
Borego																						10	CAN High: Blue CAN Low: Red						
Sedona																						9	CAN High: Red or Black CAN Low: White						
Land Rover	01 02 03 04 05 06 07 08 09 10	A	B	C	D	E	F	G	H	I	J	K	L	M	N	O	P	Q	R	S	T	U							
Freelander																						****							
Lincoln	01 02 03 04 05 06 07 08 09 10	A	B	C	D	E	F	G	H	I	J	K	L	M	N	O	P	Q	R	S	T	U							
MKZ																						14	CAN High: Gray/Orange CAN Low: Purple/Orange						
Mercedes	01 02 03 04 05 06 07 08 09 10	A	B	C	D	E	F	G	H	I	J	K	L	M	N	O	P	Q	R	S	T	U							
C230																						6	CAN High: Brown/Red CAN Low: Brown						
C32																						6	CAN High: Brown/Red CAN Low: Brown						
SLK 280																						7	CAN High: Brown/Red CAN Low: Brown						
Mitsubishi	01 02 03 04 05 06 07 08 09 10	A	B	C	D	E	F	G	H	I	J	K	L	M	N	O	P	Q	R	S	T	U							
Outlander																						18	CAN High: Yellow CAN Low: Lt. Green						
Lancer																						18	CAN High: Yellow CAN Low: Lt. Green						
Nissan	01 02 03 04 05 06 07 08 09 10	A	B	C	D	E	F	G	H	I	J	K	L	M	N	O	P	Q	R	S	T	U							
Altima																						13	CAN High: Blue CAN Low: Pink or Yellow						
Armada																						See www.ifar.ca for installation schematic / Voir www.ifar.ca pour les schéma d'installation							
Frontier																						13	CAN High: Blue CAN Low: Pink or Yellow						
Maxima																						13	CAN High: Blue CAN Low: Pink or Yellow						
Maxima Intel. Key																						13	CAN High: Blue CAN Low: Pink or Yellow						
Murano																						13	CAN High: Blue CAN Low: Pink or Yellow						
Murano Intel. Key																						13	CAN High: Blue CAN Low: Pink or Yellow						
Pathfinder																						13	CAN High: Blue CAN Low: Pink or Yellow						
Quest																						13	CAN High: Blue CAN Low: Pink or Yellow						
Rogue																						13	CAN High: Blue CAN Low: Pink or Yellow						
Sentra																						13	CAN High: Blue CAN Low: Pink or Yellow						
GTR																						13	CAN High: Blue CAN Low: Pink or Yellow						
Titan																						13	CAN High: Blue CAN Low: Pink or Yellow						
Versa																						13	CAN High: Blue CAN Low: Pink or Yellow						
Xterra																						13	CAN High: Blue CAN Low: Pink or Yellow						
350Z																						13	CAN High: Blue CAN Low: Pink or Yellow						
Pontiac	01 02 03 04 05 06 07 08 09 10	A	B	C	D	E	F	G	H	I	J	K	L	M	N	O	P	Q	R	S	T	U							
Pursuit																						15	CAN SW: Green Data Keyless: Tan/White						
G5																						15	CAN SW: Green Data Keyless: Tan/White						
G6																						15	CAN SW: Green Data Keyless: Lt. Green						
G8																						16	CAN SW: Green						
Solstice																						15	CAN SW: Green Data Keyless: Tan/White						
Torrent																						16	CAN SW: Green						
Porsche	01 02 03 04 05 06 07 08 09 10	A	B	C	D	E	F	G	H	I	J	K	L	M	N	O	P	Q	R	S	T	U							
Cayenne																						6	CAN High: Orange/Green CAN Low: Orange/Brown						
Saturn	01 02 03 04 05 06 07 08 09 10	A	B	C	D	E	F	G	H	I	J	K	L	M	N	O	P	Q	R	S	T	U							
Astra																						20	CAN SW: Green CAN Low: White CAN high: Green						
Aura																						15	CAN SW: Green Data Keyless: Lt. Green						
Outlook																						16	CAN SW: Green						
Sky																						15	CAN SW: Green Data Keyless: Tan/White						
Vue																						16	CAN SW: Green						
Subaru	01 02 03 04 05 06 07 08 09 10	A	B	C	D	E	F	G	H	I	J	K	L	M	N	O	P	Q	R	S	T	U							
Impreza																						19	CAN High: Pink CAN Low: Lt Green/Red						
Forester																						19	CAN High: Pink CAN Low: Blue						
Outback																						19	CAN High: Pink CAN Low: Purple						
Tribeca																						19	CAN High: Pink CAN Low: Purple						
Suzuki	01 02 03 04 05 06 07 08 09 10	A	B	C	D	E	F	G	H	I	J	K	L	M	N	O	P	Q	R	S	T	U							
XL7																						16	CAN SW: Green						
Grand Vitara																						12							
Volkswagen	01 02 03 04 05 06 07 08 09 10	A	B	C	D	E	F	G	H	I	J	K	L	M	N	O	P	Q	R	S	T	U							
Beetle																						2	CAN High: Orange/Green CAN Low: Orange/Brown						
Golf																						2	CAN High: Orange/Green CAN Low: Orange/Brown						
Eos																						4	CAN High: Orange/Green CAN Low: Orange/Brown						
Jetta																						4	CAN High: Orange/Green CAN Low: Orange/Brown						
Passat																						2	CAN High: Orange/Green CAN Low: Orange/Brown						
Rabbit																						4	CAN High: Orange/Green CAN Low: Orange/Brown						
Tiguan																						4	CAN High: Orange/Green CAN Low: Orange/Brown						
Touareg																						6	CAN High: Orange/Green CAN Low: Orange/Brown						
Volvo	01 02 03 04 05 06 07 08 09 10	A	B	C	D	E	F	G	H	I	J	K	L	M	N	O	P	Q	R	S	T	U							
C30																						8	CAN High: White CAN Low: Green						
C70																						8	CAN High: White CAN Low: Green						
S40																						8	CAN High: Gray/Red CAN Low: Lt. Blue/Red						
S60																						7	CAN High: White CAN Low: Green						
S80																						7	CAN High: White CAN Low: Green						

see next page | Suite page suivante

VEHICLE FIT GUIDE / GUIDE DES VÉHICULES

Volvo	01	02	03	04	05	06	07	08	09	10	A	B	C	D	E	F	G	H	I	J	K	L	M	N	O	P	Q	R	S	T	U
V50																														8	CAN High: White CAN Low: Green
V70																														7	CAN High: White CAN Low: Green
XC70																														7	CAN High: White CAN Low: Green
XC90																														7	CAN High: White CAN Low: Green

This Vehicle Fit Guide may change without notice. Visit www.ifar.ca to get latest version. Ce Guide des véhicules peut faire l'objet de changement sans préavis. Consultez le www.ifar.ca pour voir la plus récente version.

*:IK = Intelli-Key
 **:Ouverture des fenêtres (Window roll down).
 ***:Schéma de branchement (Wiring schematic configuration)
 ****: See INT-BMW-1 Installation schematic. Voir Schéma d'installation du INT-BMW-1.
 *****: Installation schematic coming soon. Schéma d'installation à venir.
 ▶ Use PATS-GM2 Utilisez le PATS-GM2

Black: Noir
 Blue: Bleu
 Brown: Brun
 Green: Vert
 Gray: Gris
 Lt: Pâle
 Orange: Orange
 Pink: Rose
 Purple: Mauve
 Red: Rouge
 Tan: Beige
 Yellow: Jaune
 White: Blanc

INSTALLATION WITH DATA-LINK / INSTALLATION AVEC DATA-LINK

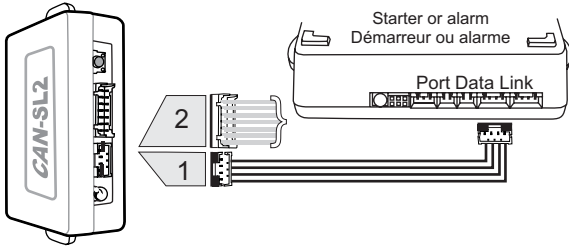

INSTALLATION WITHOUT DATA-LINK / INSTALLATION SANS DATA-LINK

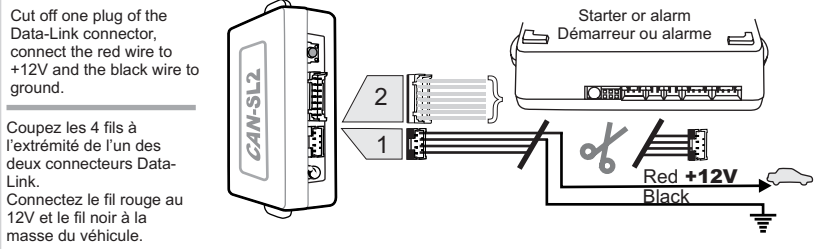

WIRING SCHEMATIC CONFIGURATION / SCHÉMA DE BRANCHEMENT

Configuration 1

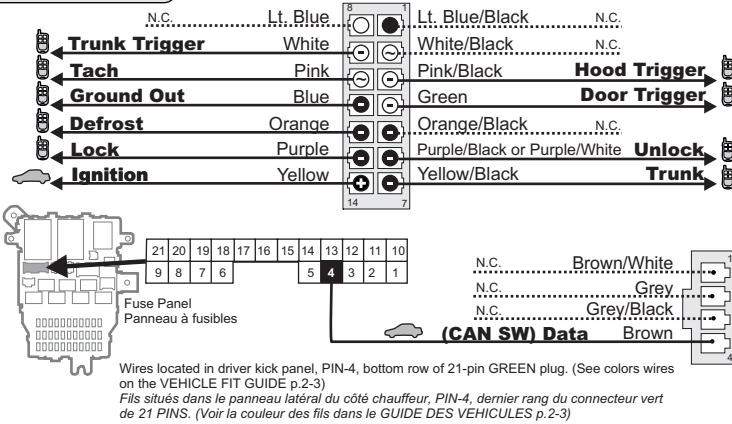

Configuration 2

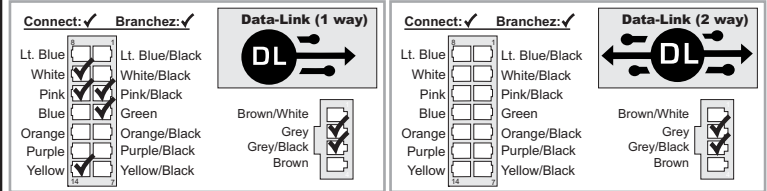
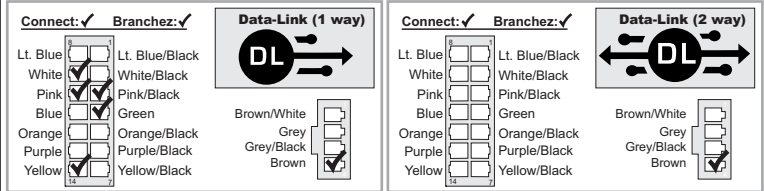
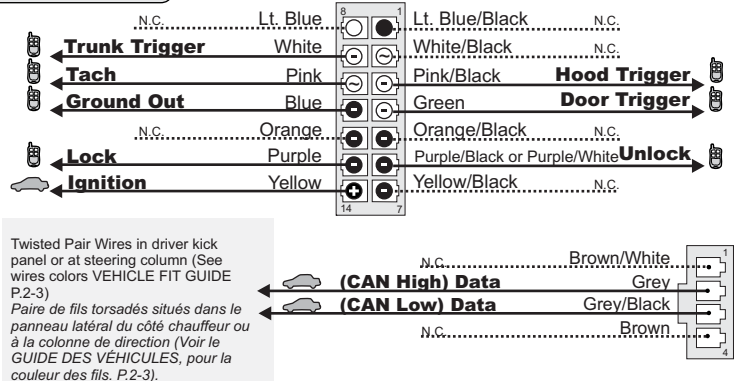

Configuration 3

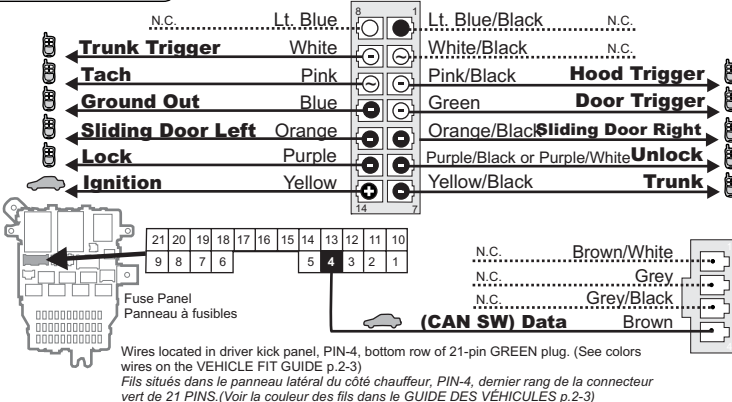

Configuration 4

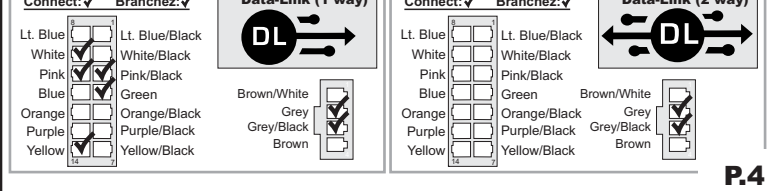
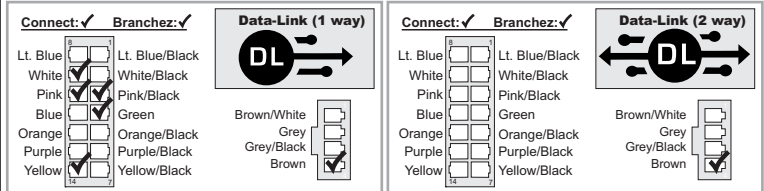
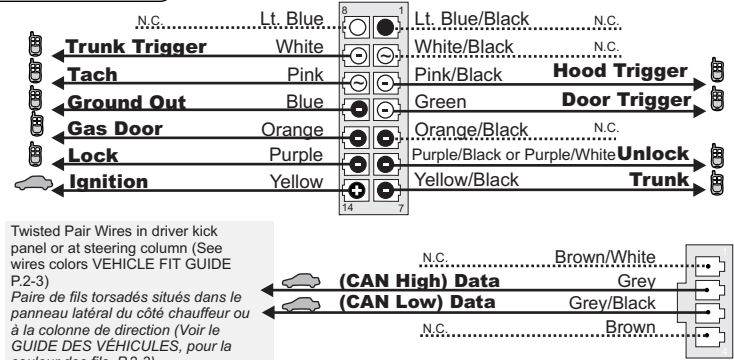

WIRING SCHEMATIC CONFIGURATION / SCHÉMA DE BRANCHEMENT

Configuration 5

Theft protection for vehicle with plastic key: if the pink/black wire is connected to remote starter you have to do **unlock** on the remote before entering the vehicle or it will shut down when you open the door.

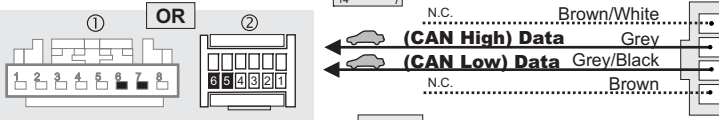
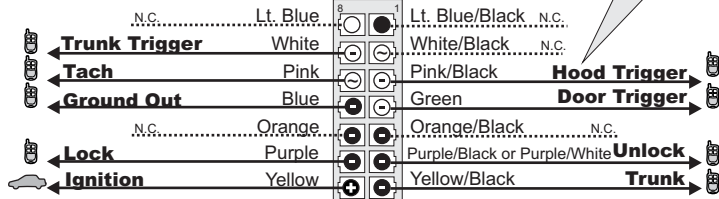

① Twisted Pair Wires located at steering column or near cluster (See colors wires on the VEHICLE FIT GUIDE p.2-3) *Paire de fils torsadés situés dans le harnais de la colonne de direction ou sous le tableau de bord. (Voir la couleur des fils dans le GUIDE DES VÉHICULES p.2-3)*

② Twisted Pair Wires located at the ignition connector (See colors wires on VEHICLE FIT GUIDE p.2-3) *Paire de fils torsadés situés au connecteur d'ignition. (Voir couleur des fils dans le GUIDE DES VÉHICULES p.2-3)*

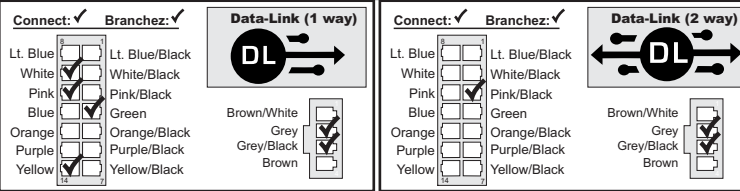

Configuration 7

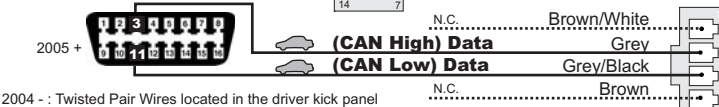
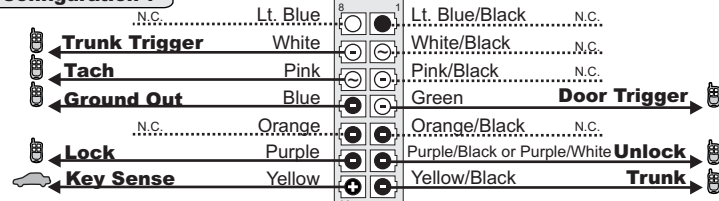

2004 - : Twisted Pair Wires located in the driver kick panel (See colors wires on the VEHICLE FIT GUIDE p.2-3) *Paire de fils torsadés situés dans le panneau latéral du côté chauffeur. (Voir la couleur des fils dans le GUIDE DES VÉHICULES p.2-3)*

2005 + : Twisted Pair Wires located in the driver kick panel (See colors wires on the VEHICLE FIT GUIDE p.2-3) *Paire de fils torsadés situés dans le panneau latéral du côté chauffeur. (Voir la couleur des fils dans le GUIDE DES VÉHICULES p.2-3)*

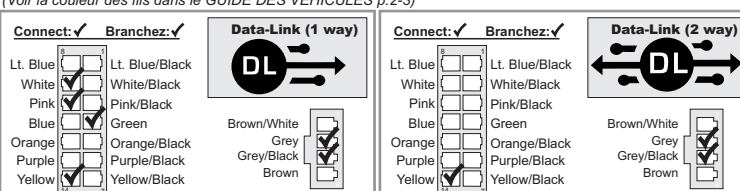

Configuration 9

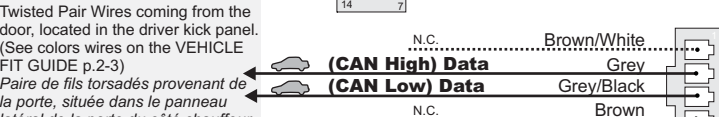
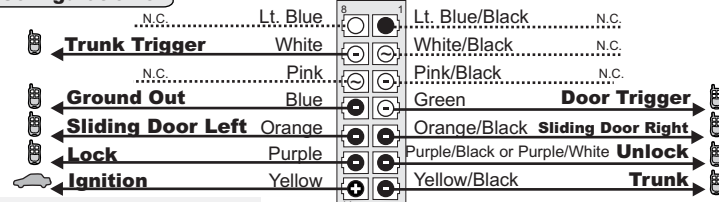

Twisted Pair Wires coming from the door, located in the driver kick panel. (See colors wires on the VEHICLE FIT GUIDE p.2-3) *Paire de fils torsadés provenant de la porte, située dans le panneau latéral de la porte du côté chauffeur. (Voir la couleur des fils dans le GUIDE DES VÉHICULES p.2-3)*

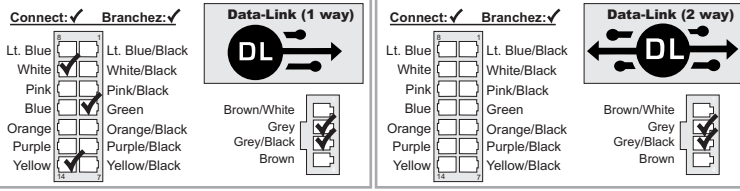

Configuration 6

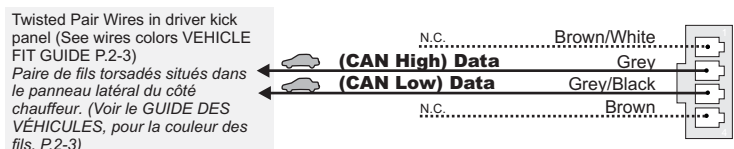
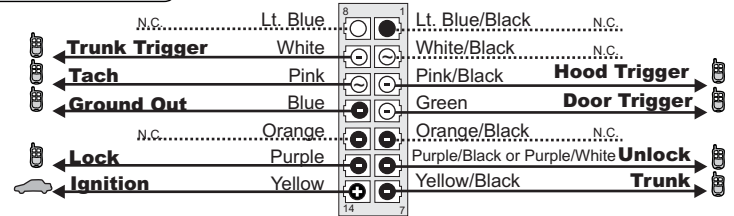

Twisted Pair Wires in driver kick panel (See wires colors VEHICLE FIT GUIDE P.2-3) *Paire de fils torsadés situés dans le panneau latéral du côté chauffeur. (Voir le GUIDE DES VÉHICULES, pour la couleur des fils. P.2-3)*

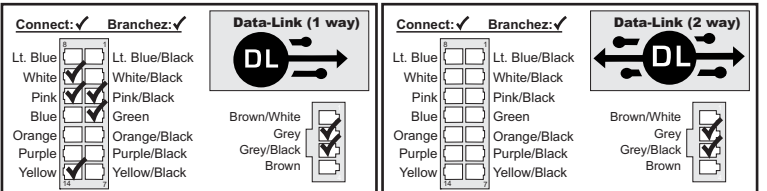

Configuration 8

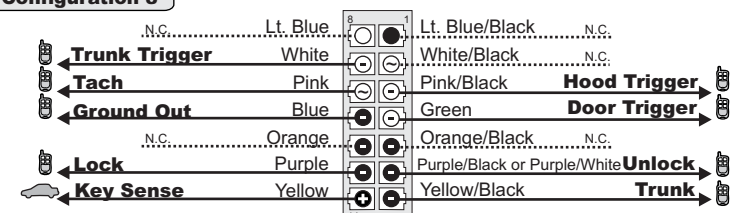

2005 + : Twisted Pair Wires located in the driver kick panel (See colors wires on the VEHICLE FIT GUIDE p.2-3) *Paire de fils torsadés situés dans le panneau latéral du côté chauffeur. (Voir la couleur des fils dans le GUIDE DES VÉHICULES p.2-3)*

2004 - : Twisted Pair Wires located in the driver kick panel (See colors wires on the VEHICLE FIT GUIDE p.2-3) *Paire de fils torsadés situés dans le panneau latéral du côté chauffeur. (Voir la couleur des fils dans le GUIDE DES VÉHICULES p.2-3)*

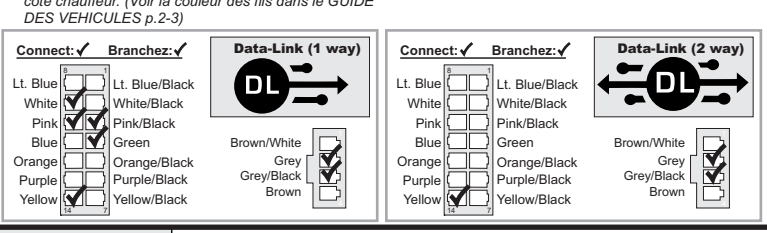

Configuration 10

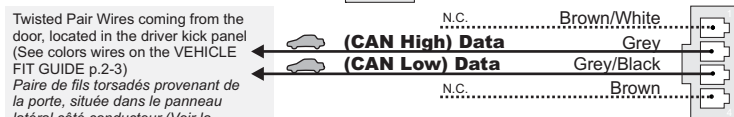
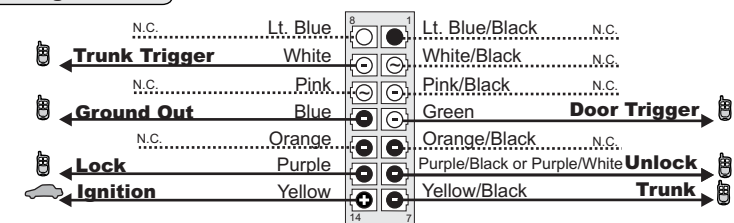

Twisted Pair Wires coming from the door, located in the driver kick panel (See colors wires on the VEHICLE FIT GUIDE p.2-3) *Paire de fils torsadés provenant de la porte, située dans le panneau latéral côté conducteur. (Voir la couleur des fils dans le GUIDE DES VÉHICULES p.2-3)*

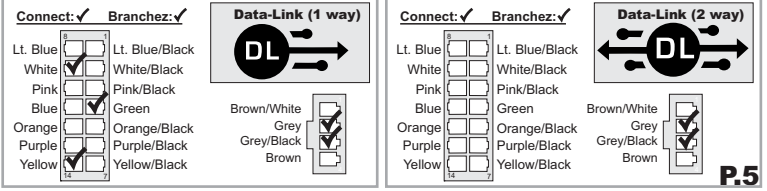

WIRING SCHEMATIC CONFIGURATION / SCHÉMA DE BRANCHEMENT

Configuration 11

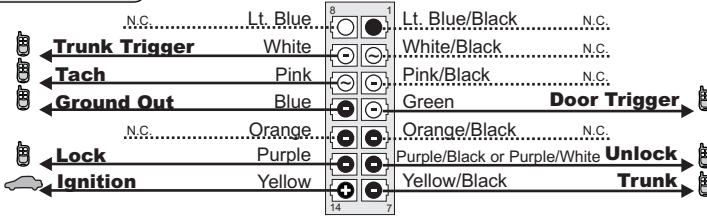

Twisted Pair Wires located under the glove compartment at the BCM. (See colors wires on the VEHICLE FIT GUIDE p.2-3)
Paire de fils torsadés situés sous le coffre à gant au BCM. (Voir la couleur des fils dans le GUIDE DES VÉHICULES p.2-3)

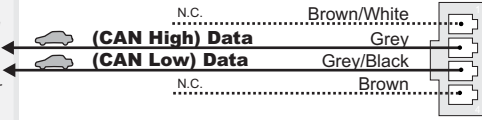

Connect: ✓ Branchez: ✓



Data-Link (1 way)

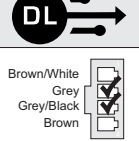

Connect: ✓ Branchez: ✓



Data-Link (2 way)

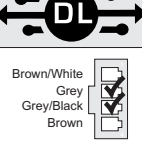

Configuration 12

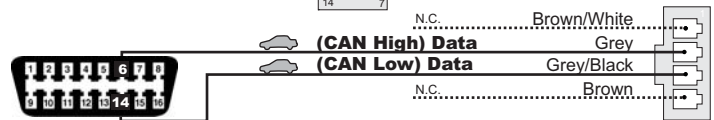
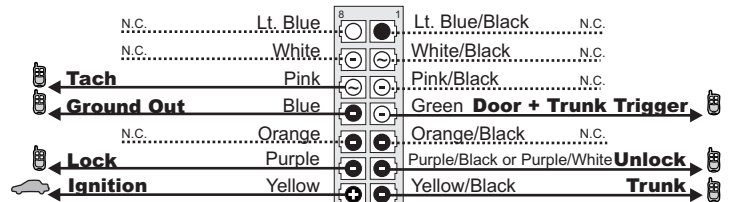

Connect: ✓ Branchez: ✓



Data-Link (1 way)

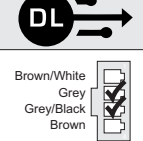

Connect: ✓ Branchez: ✓

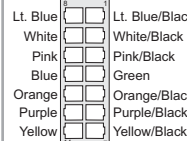

Data-Link (2 way)

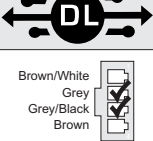

Configuration 13

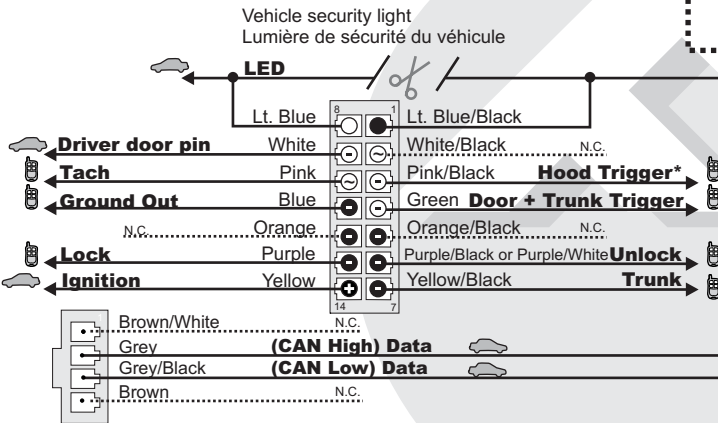

To control OEM Alarm on vehicle (NON INTELLI-KEY vehicles) add the following wires to the empty pins on the BCM.

Pour contrôler l'alarme d'origine des véhicules NON ÉQUIPÉS DE L'INTELLI-KEY ajoutez des fils dans les espaces vides du BCM.

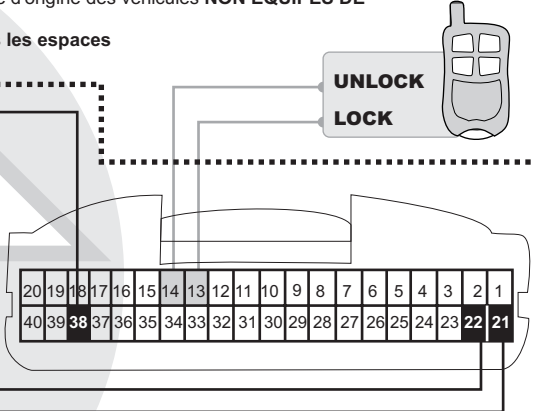

* Only if the vehicle is equipped with a hood pin.
* Seulement si le véhicule est équipé de la pin de capot.

Front view of the BCM connector located on the driver kick panel or above the acceleration pedal. For the Versa vehicle: Connector located behind the glove compartment.

Vue de face de la prise du BCM situé dans le panneau latéral conducteur ou au-dessus de la pédale d'accélération. Pour les véhicules Versa: Connecteur situé derrière le coffre à gant.

OR / OU

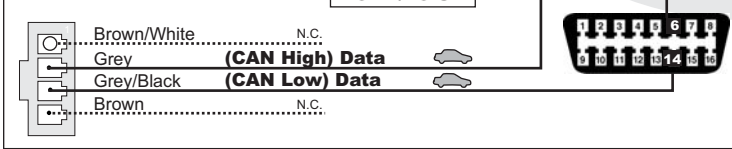

Connect: ✓ Branchez: ✓

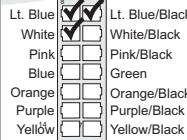

Data-Link (2 way)

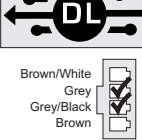

Connect: ✓ Branchez: ✓



Data-Link (1 way)

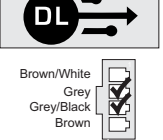

Configuration 14

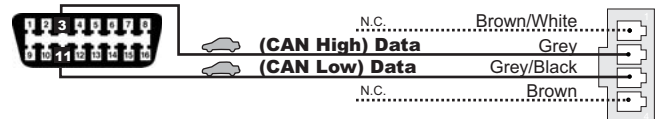
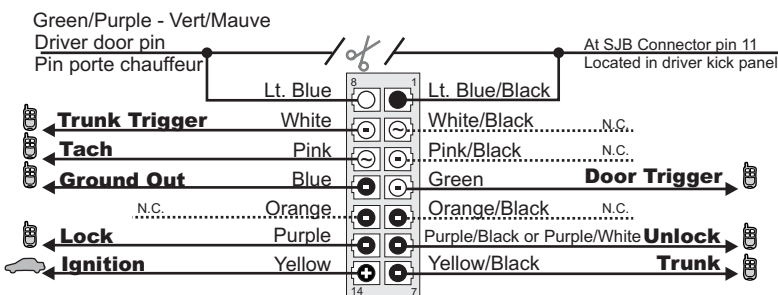

Connect: ✓ Branchez: ✓



Data-Link (1 way)

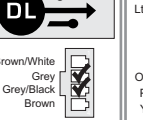

Connect: ✓ Branchez: ✓

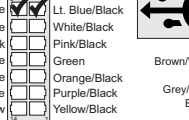

Data-Link (2 way)

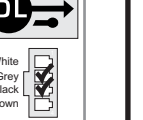

WIRING SCHEMATIC CONFIGURATION / SCHÉMA DE BRANCHEMENT

Configuration 15

Remote-Starter / Démarreur à distance

Connection for Transponder bypass./ Connexion pour le contournement transpondeur.

WARNING: All Ignition and accessory wires of the remote starter must be connected at the ignition barrel.

ATTENTION: Les fils d'ignition et d'accessoire du démarreur à distance doivent être connectés au barillet d'ignition.

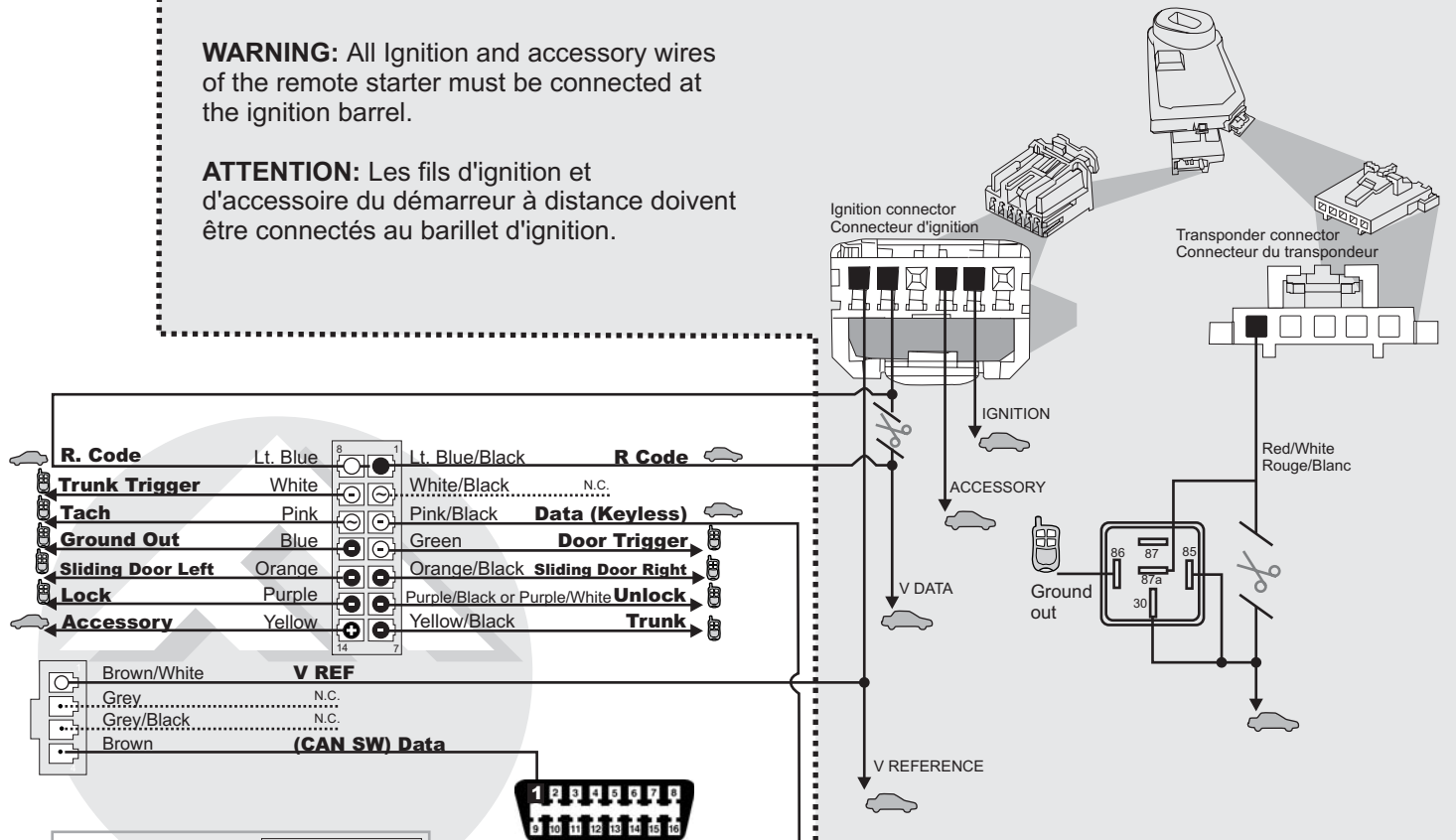

Connect: ✓	Branchez: ✓	Data-Link (1 way)	
<input checked="" type="checkbox"/>	<input checked="" type="checkbox"/>	Lt. Blue	Lt. Blue/Black
<input checked="" type="checkbox"/>	<input checked="" type="checkbox"/>	White	White/Black
<input checked="" type="checkbox"/>	<input checked="" type="checkbox"/>	Pink	Pink/Black
<input checked="" type="checkbox"/>	<input checked="" type="checkbox"/>	Blue	Green
<input checked="" type="checkbox"/>	<input checked="" type="checkbox"/>	Orange	Orange/Black
<input checked="" type="checkbox"/>	<input checked="" type="checkbox"/>	Purple	Purple/Black
<input checked="" type="checkbox"/>	<input checked="" type="checkbox"/>	Yellow	Yellow/Black
		<input checked="" type="checkbox"/>	Brown/White
		<input checked="" type="checkbox"/>	Grey
		<input checked="" type="checkbox"/>	Grey/Black
		<input checked="" type="checkbox"/>	Brown

Connect: ✓	Branchez: ✓	Data-Link (2 way)	
<input checked="" type="checkbox"/>	<input checked="" type="checkbox"/>	Lt. Blue	Lt. Blue/Black
<input checked="" type="checkbox"/>	<input checked="" type="checkbox"/>	White	White/Black
<input checked="" type="checkbox"/>	<input checked="" type="checkbox"/>	Pink	Pink/Black
<input checked="" type="checkbox"/>	<input checked="" type="checkbox"/>	Blue	Green
<input checked="" type="checkbox"/>	<input checked="" type="checkbox"/>	Orange	Orange/Black
<input checked="" type="checkbox"/>	<input checked="" type="checkbox"/>	Purple	Purple/Black
<input checked="" type="checkbox"/>	<input checked="" type="checkbox"/>	Yellow	Yellow/Black
		<input checked="" type="checkbox"/>	Brown/White
		<input checked="" type="checkbox"/>	Grey
		<input checked="" type="checkbox"/>	Grey/Black
		<input checked="" type="checkbox"/>	Brown

For OEM door lock control and trunk release
Pour contrôle du verrouillage des portes et valise.

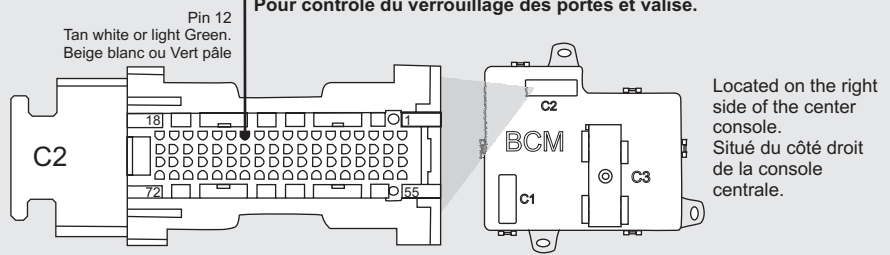

Connection needed for vehicles 2006 and older.
(Not required for vehicles 2007 and newer.)

Effectuez ce branchement pour les véhicules 2006 et moins.
(sur véhicules 2007 et plus branchement non requis)

Vehicles / Véhicules	Wire colors / Couleur(s) des fils					
	V REFERENCE	V DATA	ACCESSORY	IGNITION	CAN SW	DATA KEY LESS
Chevrolet						
Cobalt	White/Black	White	Brown	Yellow	Green	Tan/White
HHR	White/Black	White	Brown	Yellow	Green	Tan/White
Malibu	White/Black	White	Brown	Pink	Green	Lt Green
Pontiac						
G5	White/Black	White	Brown	Pink	Green	Tan/White
G6	White/Black	White	Brown	Pink	Green	Lt Green
Pursuit	White/Black	White	Brown	Yellow	Green	Tan/White
Solstice	White/Black	White	Brown	Yellow	Green	Tan/White
Saturn						
Aura	White	White/Black	Brown	Pink	Green	Lt Green
Sky	White/Black	White	Brown	Yellow	Green	Tan/White

White: Blanc Black: Noir Blue: Bleu Brown: Brun Green: Vert Gray: Gris Lt: Pâle Orange: Orange Pink: Rose Purple: Mauve Red: Rouge Tan: Beige Yellow: Jaune

WIRING SCHEMATIC CONFIGURATION / SCHÉMA DE BRANCHEMENT

Configuration 16

Remote-Starter / Démarreur à distance

Connection for Transponder bypass. / Connexion pour le contournement transpondeur.

WARNING: All Ignition and accessory wires of the remote starter must be connected at the ignition barrel.
ATTENTION: Les fils d'ignition et d'accessoire du démarreur à distance doivent être connectés au barillet d'ignition.

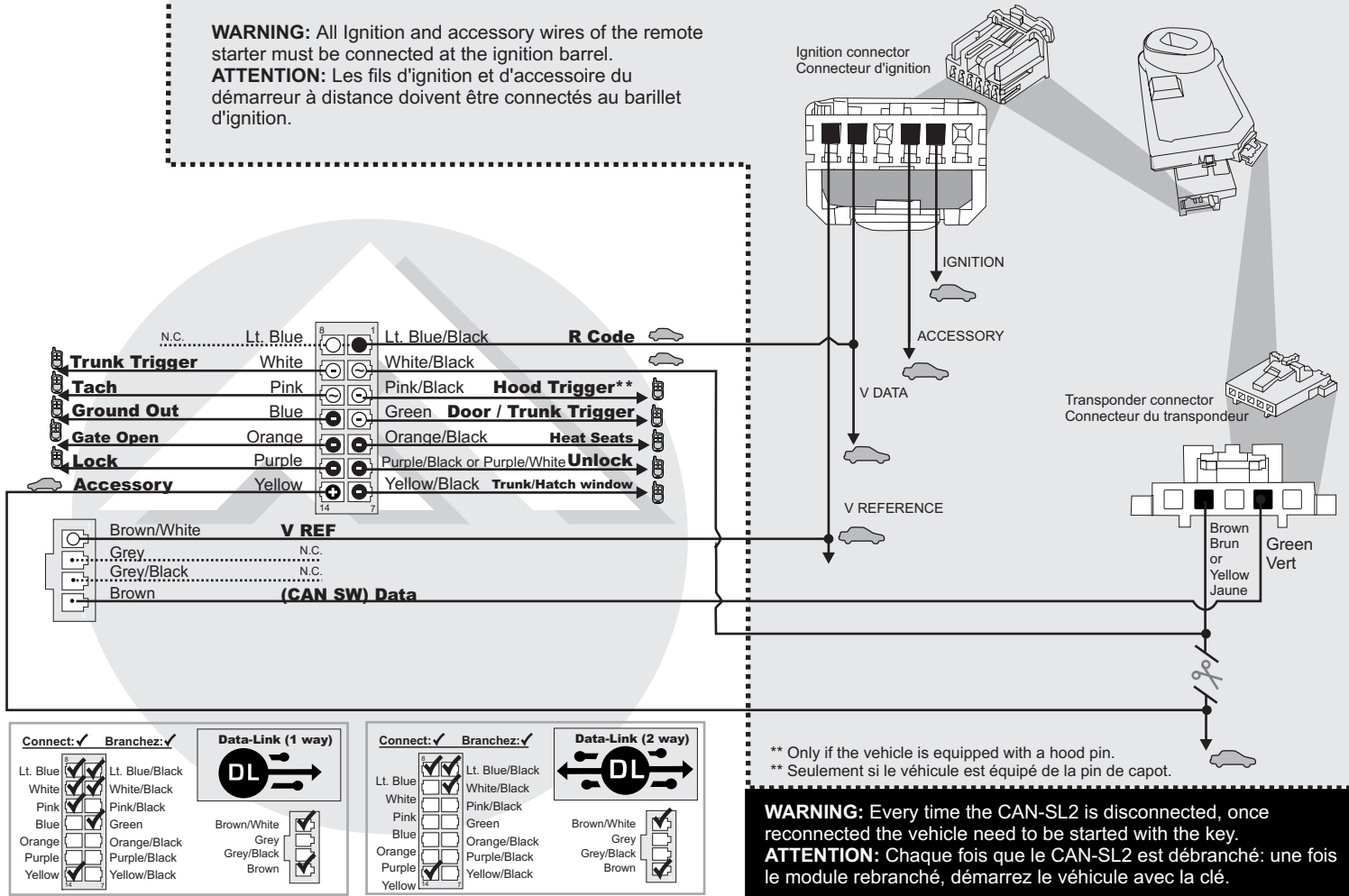

** Only if the vehicle is equipped with a hood pin.
** Seulement si le véhicule est équipé de la pin de capot.

WARNING: Every time the CAN-SL2 is disconnected, once reconnected the vehicle need to be started with the key.
ATTENTION: Chaque fois que le CAN-SL2 est débranché: une fois le module rebranché, démarrez le véhicule avec la clé.

Connect: ✓	Branchez: ✓	Data-Link (1 way)	Connect: ✓	Branchez: ✓	Data-Link (2 way)
Lt. Blue ✓	Lt. Blue/Black ✓	DL →	Lt. Blue ✓	Lt. Blue/Black ✓	← DL
White ✓	White/Black ✓		White ✓	White/Black ✓	
Pink ✓	Pink/Black ✓	Brown/White ✓ Grey ✓ Grey/Black ✓ Brown ✓	Pink ✓	Pink/Black ✓	Brown/White ✓ Grey ✓ Grey/Black ✓ Brown ✓
Blue ✓	Blue ✓		Blue ✓	Blue ✓	
Orange ✓	Orange/Black ✓		Orange ✓	Orange/Black ✓	
Purple ✓	Purple/Black ✓		Purple ✓	Purple/Black ✓	
Yellow ✓	Yellow/Black ✓		Yellow ✓	Yellow/Black ✓	

Véhicules / Vehicles	Wire colors / Couleur(s) des fils					
	V REFERENCE	V DATA	ACCESSORY	IGNITION	CAN SW	DATA KEY LESS
Buick						
Enclave	White/Black	White	Brown	Pink	Green	N.A.
Lucerne	White/Black	White	Brown	Pink	Green	N.A.
Cadillac						
CTS	White/Black	White	Brown	Pink	Green	N.A.
DTS	White/Black	White	Brown	Pink	Green	N.A.
Escalade	White	Pink/Black	Yellow	Pink	Green	N.A.
SRX	White/Black	White	Brown	Pink	Green	N.A.
STS					Green	N.A.
Chevrolet						
Avalanche	White	Pink/Black	Yellow	Pink	Green	N.A.
CK Pickup	White	Pink/Black	Yellow	Pink	Green	N.A.
Equinox	White/Black	White	Brown	Pink	Green	N.A.
Express	White	Pink	Brown	Pink	Green	N.A.
Impala	White/Black	White	Brown	Pink	Green	N.A.
Monte Carlo	White/Black	White	Brown	Pink	Green	N.A.
Silverado	White	Pink/Black	Yellow	Pink	Green	N.A.
Tahoe	White	Pink/Black	Yellow	Pink	Green	N.A.
Suburban	White	Pink/Black	Yellow	Pink	Green	N.A.
GMC						
Acadia	White/Black	White	Brown	Pink	Green	N.A.
Savana	White	White/Black	Yellow	Pink	Green	N.A.
Sierra	White	Pink/Black	Yellow	Pink	Green	N.A.
Suburban	White	Pink/Black	Yellow	Pink	Green	N.A.
Yukon	White	Pink/Black	Yellow	Pink	Green	N.A.
Saturn						
Outlook	White	White/Black	Brown	Pink	Green	N.A.
Vue	White	White/Black	Yellow	Pink	Green	N.A.
Pontiac						
G8	White/Black	White	Brown	Pink	Green	N.A.
Torrent	White/Black	White	Brown	Pink	Green	N.A.
Suzuki						
XL7	White/Black	White	Brown	Pink	Green	N.A.

WIRING SCHEMATIC CONFIGURATION / SCHÉMA DE BRANCHEMENT

Configuration 17

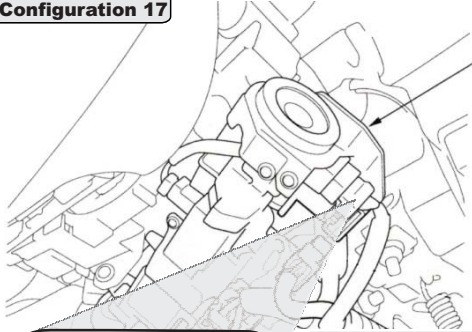

Wires located at steering column immobilizer control unit
Fils situés à la colonne de direction au module de contrôle de la clé à puce

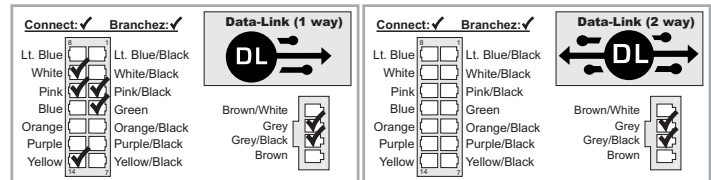
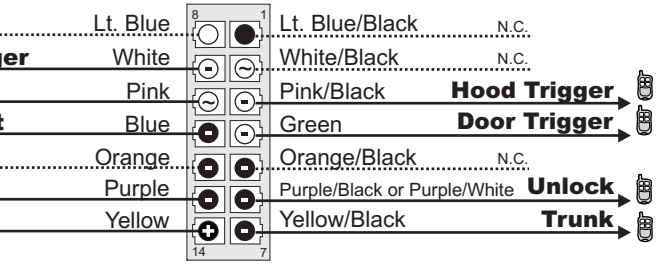
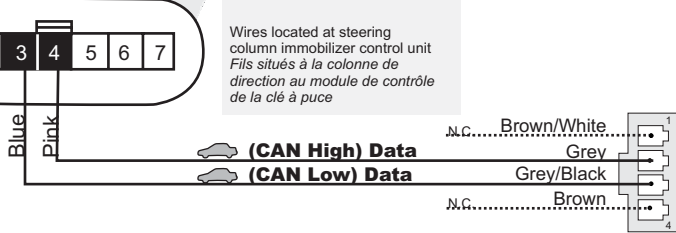

Configuration 18

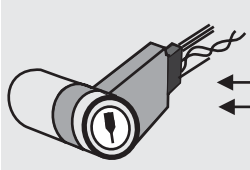
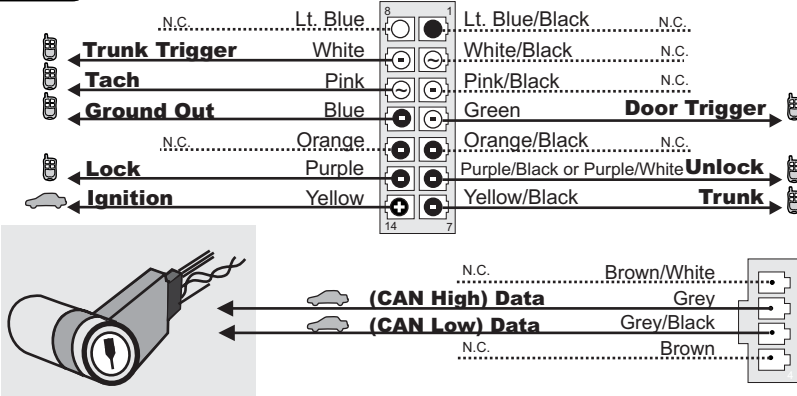

Twisted Pair Wires located at steering column or near cluster (See colors wires on the VEHICLE FIT GUIDE p.2-3)
Paire de fils torsadés situés dans le harnais de la colonne de direction ou sous le tableau de bord. (Voir la couleur des fils dans le GUIDE DES VÉHICULES p.2-3)

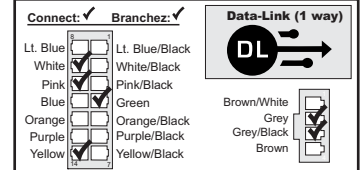
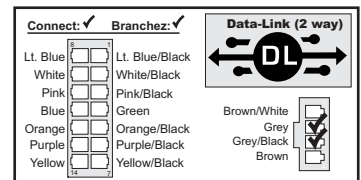

Configuration 19

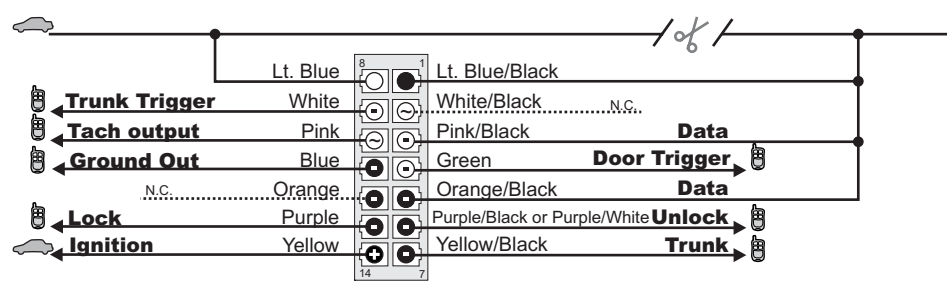

BCM located directly below the steering column.
BCM situés directement sous la colonne de direction.

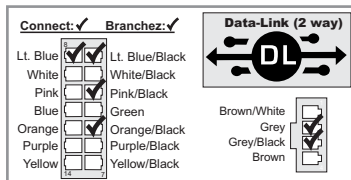
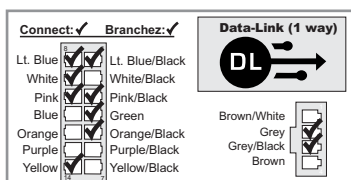
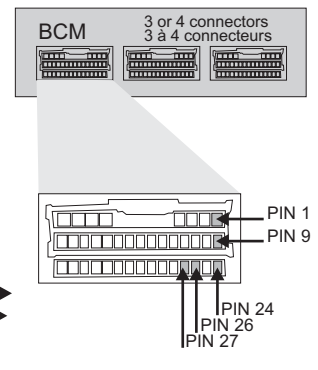

Vehicles Véhicules	Wire colors / Couleur(s) des fils					
	CAN HIGH	PIN	CAN LOW	PIN	DATA BCM	PIN
Subaru						
Impreza	Pink	1	Lt Green/Red	9	Yellow/Green	24
Forester	Pink	1	Blue	9	White/Red	24
Outback	Pink	26	Purple	27	Yellow	9
Tribeca	Pink	26	Purple	27	Yellow/Green	9



WIRING SCHEMATIC CONFIGURATION / SCHÉMA DE BRANCHEMENT

Configuration 20



REMOTE STARTER
The remote starters starter output is not required.

DÉMARREUR À DISTANCE
La sortie Start du démarreur à distance n'est pas requise pour ce véhicule.

Ignition
Accessory

Make 10 loops with a 22 to 26 gauge wire around the factory key.
Faire 10 tours autour de la clé d'origine avec un fil de calibre 22 à 26.

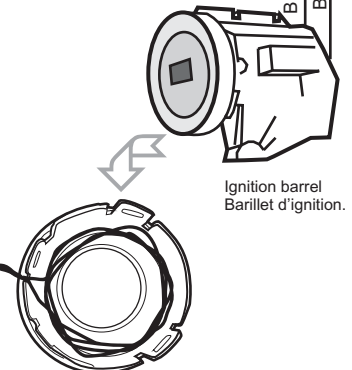
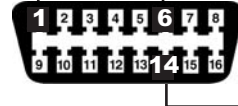
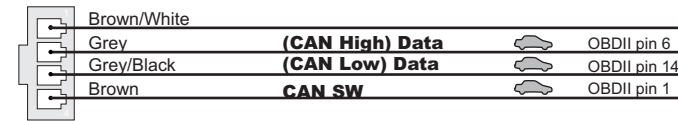
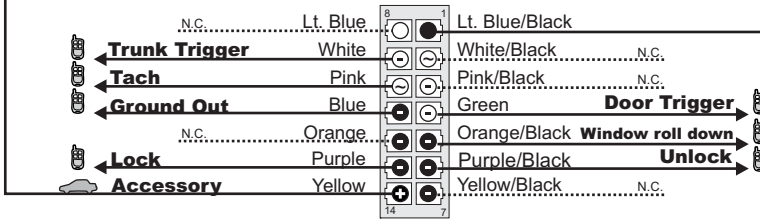

- 1 Remove the plastic cover of the Ignition barrel
Retirez le couvert de plastique du barillet d'ignition.
- 2 Wrap the wire around the inside of the plastic ring 4 times.
Faire 4 tours à l'intérieur de l'anneau de plastique avec le fil.

<p>Connect: ✓ Branchez: ✓</p> <table border="1"> <tr><td>Lt. Blue</td><td><input type="checkbox"/></td></tr> <tr><td>White</td><td><input checked="" type="checkbox"/></td></tr> <tr><td>Pink</td><td><input checked="" type="checkbox"/></td></tr> <tr><td>Blue</td><td><input checked="" type="checkbox"/></td></tr> <tr><td>Orange</td><td><input type="checkbox"/></td></tr> <tr><td>Purple</td><td><input type="checkbox"/></td></tr> <tr><td>Yellow</td><td><input checked="" type="checkbox"/></td></tr> </table>	Lt. Blue	<input type="checkbox"/>	White	<input checked="" type="checkbox"/>	Pink	<input checked="" type="checkbox"/>	Blue	<input checked="" type="checkbox"/>	Orange	<input type="checkbox"/>	Purple	<input type="checkbox"/>	Yellow	<input checked="" type="checkbox"/>	<p>Connect: ✓ Branchez: ✓</p> <table border="1"> <tr><td>Lt. Blue/Black</td><td><input type="checkbox"/></td></tr> <tr><td>White/Black</td><td><input type="checkbox"/></td></tr> <tr><td>Pink/Black</td><td><input type="checkbox"/></td></tr> <tr><td>Green</td><td><input type="checkbox"/></td></tr> <tr><td>Orange/Black</td><td><input type="checkbox"/></td></tr> <tr><td>Purple/Black</td><input type="checkbox"/></tr></table>	Lt. Blue/Black	<input type="checkbox"/>	White/Black	<input type="checkbox"/>	Pink/Black	<input type="checkbox"/>	Green	<input type="checkbox"/>	Orange/Black	<input type="checkbox"/>	Purple/Black
Lt. Blue	<input type="checkbox"/>																									
White	<input checked="" type="checkbox"/>																									
Pink	<input checked="" type="checkbox"/>																									
Blue	<input checked="" type="checkbox"/>																									
Orange	<input type="checkbox"/>																									
Purple	<input type="checkbox"/>																									
Yellow	<input checked="" type="checkbox"/>																									
Lt. Blue/Black	<input type="checkbox"/>																									
White/Black	<input type="checkbox"/>																									
Pink/Black	<input type="checkbox"/>																									
Green	<input type="checkbox"/>																									
Orange/Black	<input type="checkbox"/>																									
Purple/Black																										
Yellow/Black	<input type="checkbox"/>																									

 Data-Link (1 way) **DL** → | | | |-------------|-------------------------------------| | Brown/White | <input checked="" type="checkbox"/> | | Grey | <input checked="" type="checkbox"/> | | Grey/Black | <input checked="" type="checkbox"/> | | Brown | <input checked="" type="checkbox"/> | | **Connect: ✓ Branchez: ✓** | | | |----------|-------------------------------------| | Lt. Blue | <input checked="" type="checkbox"/> | | White | <input type="checkbox"/> | | Pink | <input type="checkbox"/> | | Blue | <input type="checkbox"/> | | Orange | <input type="checkbox"/> | | Purple | <input type="checkbox"/> | | Yellow | <input checked="" type="checkbox"/> | | **Connect: ✓ Branchez: ✓** | | | |----------------|--------------------------| | Lt. Blue/Black | <input type="checkbox"/> | | White/Black | <input type="checkbox"/> | | Pink/Black | <input type="checkbox"/> | | Green | <input type="checkbox"/> | | Orange/Black | <input type="checkbox"/> | | Purple/Black | <input type="checkbox"/> | | Yellow/Black | <input type="checkbox"/> | | **Data-Link (2 way)** ← **DL** → | | | |-------------|-------------------------------------| | Brown/White | <input checked="" type="checkbox"/> | | Grey | <input checked="" type="checkbox"/> | | Grey/Black | <input checked="" type="checkbox"/> | | Brown | <input checked="" type="checkbox"/> | |



MODULE D'INTERFACE CAN BUS POUR ALARME ET DÉMARREUR À DISTANCE



CÂBLAGE / GUIDE DE CONNEXION

Voir SCHÉMA DE BRANCHEMENT

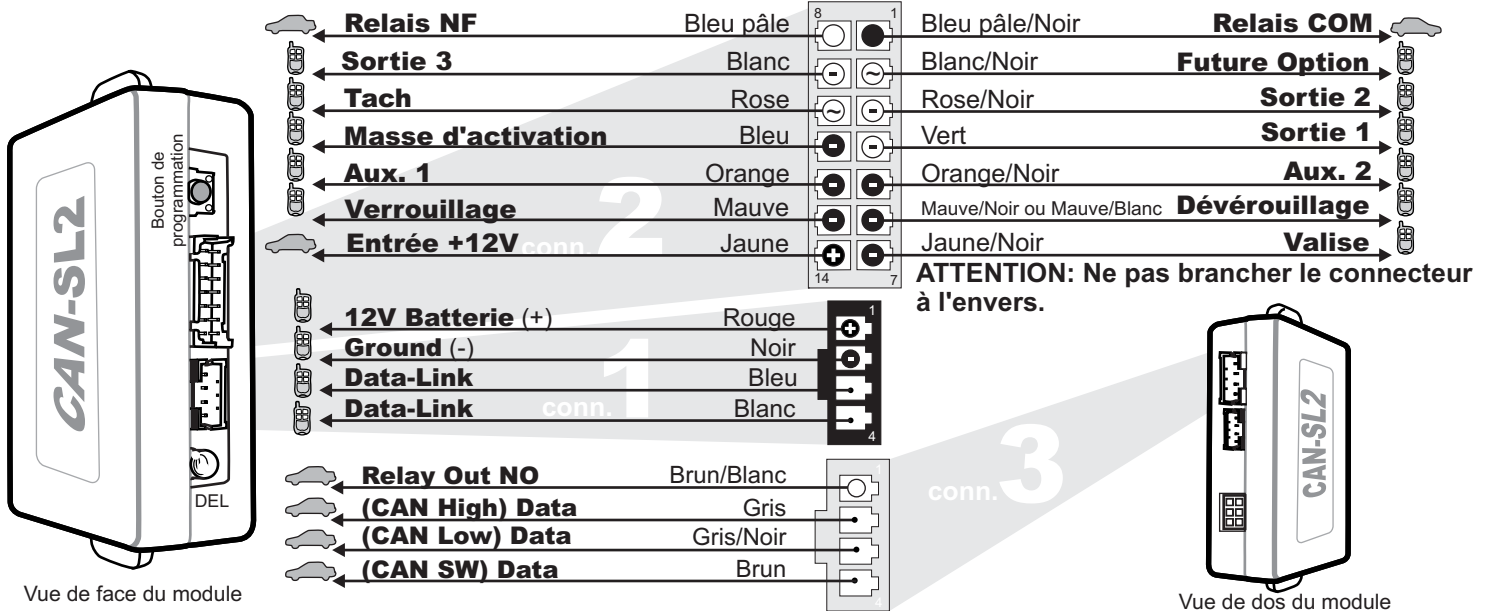

Vue de face du module

Vue de dos du module

Branchement du filage au démarreur à distance/Alarme Branchement du filage au véhicule SORTIE ENTRÉE

COMMENCEZ ICI

INSTRUCTIONS D'INSTALLATION ET DE PROGRAMMATION

1 Effectuez les connexions du CAN-SL2 au véhicule:

1.A **Connecteur 1 (Noir):**
Déterminez le type d'installation (Data-Link ou non Data-Link)
Pour l'installation DATA-LINK assurez vous de la présence du connecteur DATA-LINK sur le démarreur. (Voir INSTALLATION AVEC DATA-LINK (P.4)).
Pour installation non Data-Link voir INSTALLATION SANS DATA-LINK (P.4).

1.B **Connecteur 2 (Blanc):**
Déterminez le type de branchement selon votre véhicule (Voir GUIDE DES VOITURES, P.2-3)

1.C **Connecteur 3 (Blanc, situé au dos du module):**
Déterminez le type de branchement selon votre véhicule (Voir GUIDE DES VOITURES, P.2-3)

2 **Maintenez le bouton de programmation enfoncé** en insérant le **connecteur 1** dans le CAN-SL2.
Le DEL s'allume pour indiquer le début de la programmation, **relâchez le bouton de programmation.**

3 Branchez le connecteur 2 (CONN. 2)

ATTENTION: Ne pas brancher le connecteur à l'envers.

4 Branchez le connecteur 3 (CONN. 3)

5 Tournez la clef en position **ignition**.

6 Lorsque le DEL clignote rapidement, **tournez la clef en position OFF.** (Sauf véhicules GMC: démarrez le véhicule).
Le DEL s'éteint pour indiquer que le module est programmé.

(* Sauf pour les véhicules Chrysler, Dodge, Jeep, poursuivre à l'étape 7)

* Chrysler/Dodge/Jeep

7 Le DEL clignotera jusqu'à ce que vous pressiez le bouton Verrouillage (Lock) de la télécommande d'origine du véhicule.
Le DEL s'éteint pour indiquer que le module est programmé.

INFORMATIONS / SUPPORT TECHNIQUE

Ni le fabricant, ni le distributeur ne se considèrent responsables des dommages causés ou ayant pu être causés, indirectement ou directement, par ce module, excepté le remplacement de ce module en cas de défectuosité de fabrication. Ce module doit être installé par un technicien qualifié. Ce guide d'instruction peut faire l'objet de changement sans préavis. Consultez le www.ifar.ca pour voir la plus récente version.

Support Technique:
TEL: 514-255-HELP (4357)
FAX: 514-255-1367
Web: www.ifar.ca

