



**SATURN Sky**

**2006**



**CAN-SL-PL AND TBGM2**

Made in Canada Rev. B - 01 / 02 / 2009  
Web site: <http://www.ifar.ca>

**ALARM AND REMOTE STARTER CAN BUS INTERFACE KIT**

**Fonctionnel if equipped**

- |  |   |  |   |
|--|---|--|---|
| <input checked="" type="checkbox"/> Lock   | <input checked="" type="checkbox"/> Tach          | <input checked="" type="checkbox"/> Radio Off          | <input type="checkbox"/> Heat Seats       |
| <input checked="" type="checkbox"/> Unlock | <input checked="" type="checkbox"/> Start Enable  | <input checked="" type="checkbox"/> Transponder Bypass | <input type="checkbox"/> Gas Door         |
| <input checked="" type="checkbox"/> Arm    | <input checked="" type="checkbox"/> Door Trigger  | <input checked="" type="checkbox"/> PK3, Passlock      | <input type="checkbox"/> Window Roll Down |
| <input checked="" type="checkbox"/> Disarm | <input checked="" type="checkbox"/> Trunk Trigger | <input type="checkbox"/> Sliding Door                  | <input type="checkbox"/> Hatch            |
| <input checked="" type="checkbox"/> Trunk  | <input type="checkbox"/> Hood Trigger             | <input type="checkbox"/> Defrost                       | <input type="checkbox"/> Brake Signal     |

**Remote-Starter / Démarreur à distance**

**WARNING:** All Ignition and accessory wires of the remote starter must be connected at the ignition barrel.

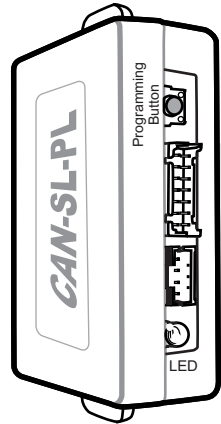
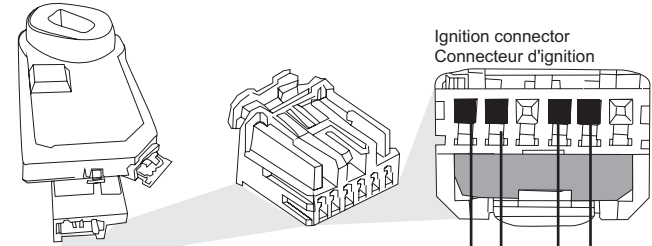

Front of the module

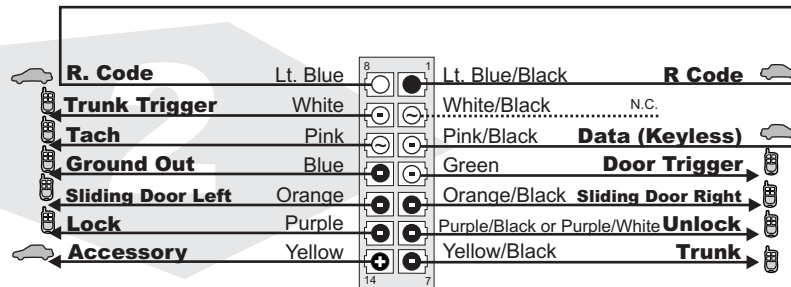
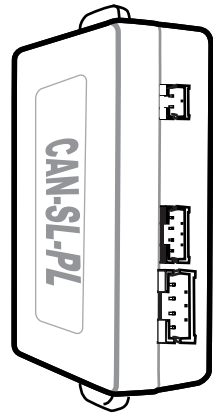

For OEM door lock control and trunk release. Pin 12 Tan/White

Located on the right side of the center console.

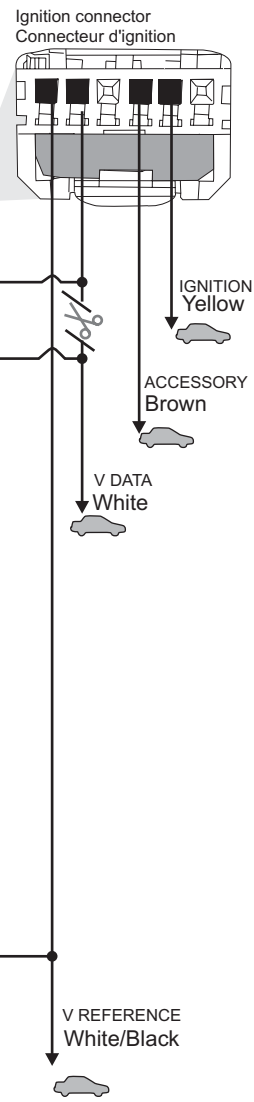
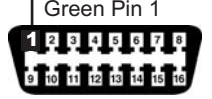
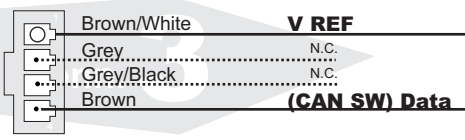
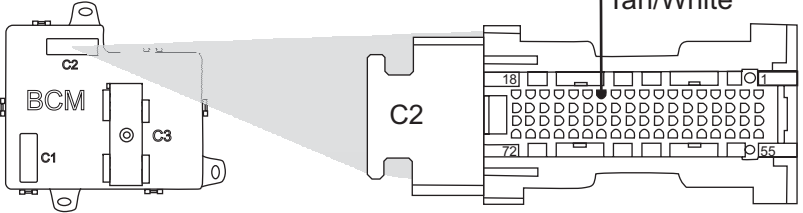

Connect wire to Remote-Starter/Alarm Connect wire to vehicle

○ OUTPUT ● INPUT

<p><b>Connect:</b> ✓ <b>Branchez:</b> ✓</p> <table border="0"> <tr><td>Lt. Blue</td><td><input checked="" type="checkbox"/></td><td>Lt. Blue/Black</td><td><input checked="" type="checkbox"/></td></tr> <tr><td>White</td><td><input checked="" type="checkbox"/></td><td>White/Black</td><td><input checked="" type="checkbox"/></td></tr> <tr><td>Pink</td><td><input checked="" type="checkbox"/></td><td>Pink/Black</td><td><input checked="" type="checkbox"/></td></tr> <tr><td>Blue</td><td><input checked="" type="checkbox"/></td><td>Green</td><td><input checked="" type="checkbox"/></td></tr> <tr><td>Orange</td><td><input type="checkbox"/></td><td>Orange/Black</td><td><input type="checkbox"/></td></tr> <tr><td>Purple</td><td><input type="checkbox"/></td><td>Purple/Black</td><td><input type="checkbox"/></td></tr> <tr><td>Yellow</td><td><input type="checkbox"/></td><td>Yellow/Black</td><td><input type="checkbox"/></td></tr> </table>	Lt. Blue	<input checked="" type="checkbox"/>	Lt. Blue/Black	<input checked="" type="checkbox"/>	White	<input checked="" type="checkbox"/>	White/Black	<input checked="" type="checkbox"/>	Pink	<input checked="" type="checkbox"/>	Pink/Black	<input checked="" type="checkbox"/>	Blue	<input checked="" type="checkbox"/>	Green	<input checked="" type="checkbox"/>	Orange	<input type="checkbox"/>	Orange/Black	<input type="checkbox"/>	Purple	<input type="checkbox"/>	Purple/Black	<input type="checkbox"/>	Yellow	<input type="checkbox"/>	Yellow/Black	<input type="checkbox"/>	<p><b>Data-Link (1 way)</b></p> <table border="0"> <tr><td>Brown/White</td><td><input checked="" type="checkbox"/></td></tr> <tr><td>Grey</td><td><input type="checkbox"/></td></tr> <tr><td>Grey/Black</td><td><input checked="" type="checkbox"/></td></tr> <tr><td>Brown</td><td><input type="checkbox"/></td></tr> </table>	Brown/White	<input checked="" type="checkbox"/>	Grey	<input type="checkbox"/>	Grey/Black	<input checked="" type="checkbox"/>	Brown	<input type="checkbox"/>	<p><b>Connect:</b> ✓ <b>Branchez:</b> ✓</p> <table border="0"> <tr><td>Lt. Blue</td><td><input checked="" type="checkbox"/></td><td>Lt. Blue/Black</td><td><input checked="" type="checkbox"/></td></tr> <tr><td>White</td><td><input type="checkbox"/></td><td>White/Black</td><td><input type="checkbox"/></td></tr> <tr><td>Pink</td><td><input checked="" type="checkbox"/></td><td>Pink/Black</td><td><input type="checkbox"/></td></tr> <tr><td>Blue</td><td><input checked="" type="checkbox"/></td><td>Green</td><td><input type="checkbox"/></td></tr> <tr><td>Orange</td><td><input type="checkbox"/></td><td>Orange/Black</td><td><input type="checkbox"/></td></tr> <tr><td>Purple</td><td><input type="checkbox"/></td><td>Purple/Black</td><td><input type="checkbox"/></td></tr> <tr><td>Yellow</td><td><input type="checkbox"/></td><td>Yellow/Black</td><td><input type="checkbox"/></td></tr> </table>	Lt. Blue	<input checked="" type="checkbox"/>	Lt. Blue/Black	<input checked="" type="checkbox"/>	White	<input type="checkbox"/>	White/Black	<input type="checkbox"/>	Pink	<input checked="" type="checkbox"/>	Pink/Black	<input type="checkbox"/>	Blue	<input checked="" type="checkbox"/>	Green	<input type="checkbox"/>	Orange	<input type="checkbox"/>	Orange/Black	<input type="checkbox"/>	Purple	<input type="checkbox"/>	Purple/Black	<input type="checkbox"/>	Yellow	<input type="checkbox"/>	Yellow/Black	<input type="checkbox"/>	<p><b>Data-Link (2 way)</b></p> <table border="0"> <tr><td>Brown/White</td><td><input checked="" type="checkbox"/></td></tr> <tr><td>Grey</td><td><input type="checkbox"/></td></tr> <tr><td>Grey/Black</td><td><input type="checkbox"/></td></tr> <tr><td>Brown</td><td><input checked="" type="checkbox"/></td></tr> </table>	Brown/White	<input checked="" type="checkbox"/>	Grey	<input type="checkbox"/>	Grey/Black	<input type="checkbox"/>	Brown	<input checked="" type="checkbox"/>
Lt. Blue	<input checked="" type="checkbox"/>	Lt. Blue/Black	<input checked="" type="checkbox"/>																																																																								
White	<input checked="" type="checkbox"/>	White/Black	<input checked="" type="checkbox"/>																																																																								
Pink	<input checked="" type="checkbox"/>	Pink/Black	<input checked="" type="checkbox"/>																																																																								
Blue	<input checked="" type="checkbox"/>	Green	<input checked="" type="checkbox"/>																																																																								
Orange	<input type="checkbox"/>	Orange/Black	<input type="checkbox"/>																																																																								
Purple	<input type="checkbox"/>	Purple/Black	<input type="checkbox"/>																																																																								
Yellow	<input type="checkbox"/>	Yellow/Black	<input type="checkbox"/>																																																																								
Brown/White	<input checked="" type="checkbox"/>																																																																										
Grey	<input type="checkbox"/>																																																																										
Grey/Black	<input checked="" type="checkbox"/>																																																																										
Brown	<input type="checkbox"/>																																																																										
Lt. Blue	<input checked="" type="checkbox"/>	Lt. Blue/Black	<input checked="" type="checkbox"/>																																																																								
White	<input type="checkbox"/>	White/Black	<input type="checkbox"/>																																																																								
Pink	<input checked="" type="checkbox"/>	Pink/Black	<input type="checkbox"/>																																																																								
Blue	<input checked="" type="checkbox"/>	Green	<input type="checkbox"/>																																																																								
Orange	<input type="checkbox"/>	Orange/Black	<input type="checkbox"/>																																																																								
Purple	<input type="checkbox"/>	Purple/Black	<input type="checkbox"/>																																																																								
Yellow	<input type="checkbox"/>	Yellow/Black	<input type="checkbox"/>																																																																								
Brown/White	<input checked="" type="checkbox"/>																																																																										
Grey	<input type="checkbox"/>																																																																										
Grey/Black	<input type="checkbox"/>																																																																										
Brown	<input checked="" type="checkbox"/>																																																																										



**Technical support:**  
TEL: 514-255-HELP (4357)  
FAX: 514-255-1367  
Web: [www.ifar.ca](http://www.ifar.ca)

Neither the manufacturer or distributor of this module is responsible of damages of any kind indirectly or directly caused by this module, except for the replacement of this module in case of manufacturing defects. This module must be install by qualified technician. This instruction guide may change without notice. Visit [www.ifar.ca](http://www.ifar.ca) to get latest version.



# SATURN Sky

# 2006



## CAN-SL-PL AND TBGM2

Made in Canada Rev. B - 01 / 02 / 2009  
Web site: <http://www.ifar.ca>

### ALARM AND REMOTE STARTER CAN BUS INTERFACE KIT

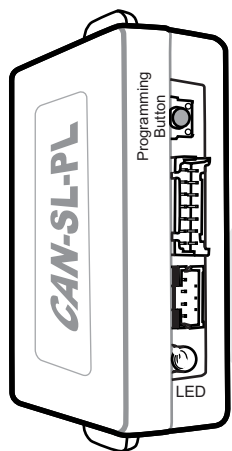

Front of the module

**Connector 1 (Black - 4 pins):**  
Determine the type of installation:

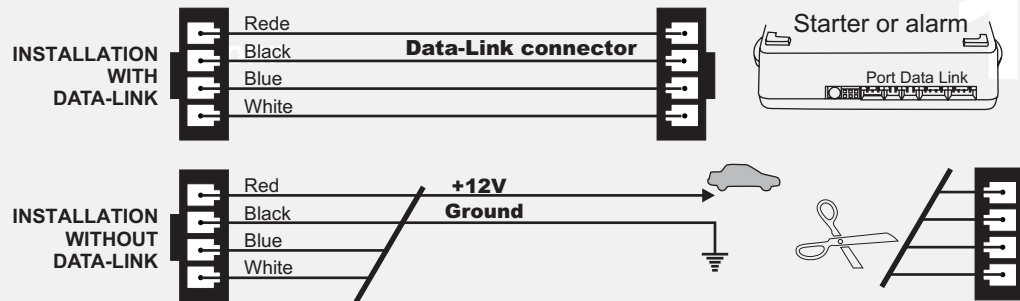

Cut off one plug of the Data-Link connector, connect the red wire to +12V and the black wire to ground.

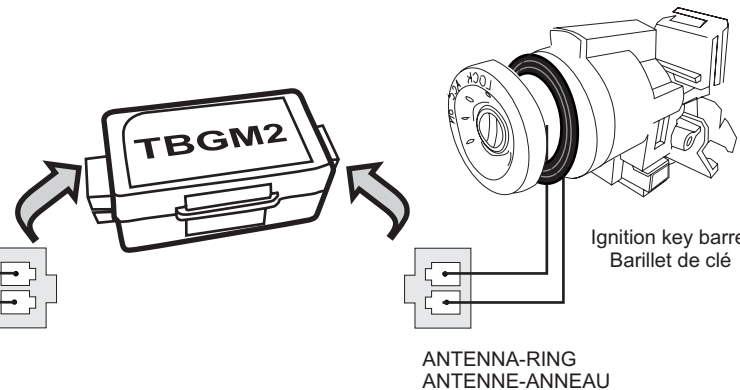
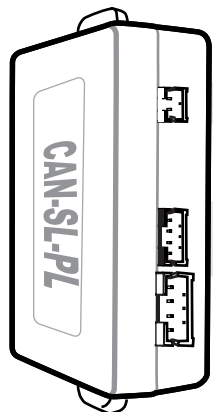

**Web Update connector\***  
\* Connector not supplied

**Connector 4 (White - 4 pins):**  
Connect with the **FLASH LINK UPDATER** for web update.

Connect wire to Remote-Starter/Alarm Connect wire to vehicle ○ OUTPUT ● INPUT



**Technical support:**  
TEL: 514-255-HELP (4357)  
FAX: 514-255-1367  
Web: [www.ifar.ca](http://www.ifar.ca)

Neither the manufacturer or distributor of this module is responsible of damages of any kind indirectly or directly caused by this module, except for the replacement of this module in case of manufacturing defects. This module must be install by qualified technician. This instruction guide may change without notice. Visit [www.ifar.ca](http://www.ifar.ca) to get latest version.



# CAN-SL-PL AND TBGM2

Made in Canada - Rev. B - 01 / 02 / 2009  
Web site: <http://www.ifar.ca>

ALARM AND REMOTE STARTER CAN BUS INTERFACE KIT

## CAN-SL-PL PROGRAMMING

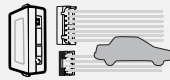
**1** **1.A**  **Make the connections of the CAN-SL-PL to the vehicle:**

**Connector 1 (Black):**  
Determine the type of installation:  
INSTALLATION WITH DATA-LINK  
INSTALLATION WITHOUT DATA-LINK

**1.B**  **Connector 2 (White):**  
Make the connections

**1.C**  **Connector 3 (White, located at the back of the module):**  
Make the connections

**2**  **Press** the programming switch while inserting the main wires harness (**CONN 1**) into the CAN-SL-PL module. The LED will illuminate to indicate you are in programming mode, release the programming button.

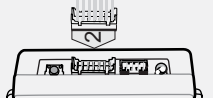
**3**  **Connect** the other connectors (**CONN. 2**)

**WARNING: Connector 2 can be easily plugged in backwards.**

**4**  **Connect** the other connectors (**CONN. 3**)

**5**  Turn the key to the **"ON" position**.

**6**  Once the LED starts to flash rapidly turn the key to the **OFF position**.

The LED will turn off to indicate the module has been programmed.

 **The module is now ready for use.**

## TBGM2 PROGRAMMING

**7**  Insert the key and turn the cylinder to the **ON/RUN** position for **1 second**.

**8**  Remove the key.

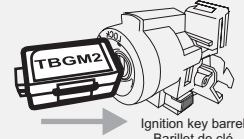
**9**  Place the TBGM2 module close to the front of the ignition barrel.

Ignition key barrel  
Barillet de clé

**YOU HAVE 5 SECONDS TO COMPLETE THE FOLLOWING STEP**

**10**  Remote-Start the vehicle. **THE TBGM2 IS NOW PROGRAMMED.**

**IMPORTANT:**  
Once the **TBGM2** is programmed, it can not be programmed on another vehicle.

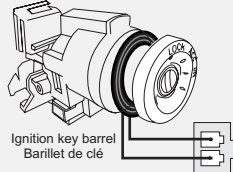
**11**  **Remove** the trim cap from the ignition barrel.  
**Stick** the antenna to the ignition barrel.  
**Replace** the trim cap on the ignition barrel.

Ignition key barrel  
Barillet de clé

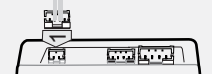
**12**  Connect the TBGM2 module to the CAN-SL-PL using the PATS-LINK cable.



# SATURN Sky

## 2006



# CAN-SL-PL ET TBGM2

Fabriqu  au Canada Rev.B - 01 / 02 / 2009  
Site internet <http://www.ifar.ca>

MODULE D'INTERFACE CAN BUS POUR ALARME ET D MARREUR   DISTANCE

### Fonctionnal if equipped

- |  |  |  |  |
|--|--|--|--|
| <input checked="" type="checkbox"/> Verrouillage   | <input checked="" type="checkbox"/> Tach             | <input checked="" type="checkbox"/> Radio Off          | <input type="checkbox"/> Si ges chauffants |
| <input checked="" type="checkbox"/> D verrouillage | <input checked="" type="checkbox"/> Active D marreur | <input checked="" type="checkbox"/> Transponder Bypass | <input type="checkbox"/> Porte essence     |
| <input checked="" type="checkbox"/> Armement       | <input checked="" type="checkbox"/> Status de Porte  | <input checked="" type="checkbox"/> PK3, Passlock      | <input type="checkbox"/> Contr le portes   |
| <input checked="" type="checkbox"/> D sarmement    | <input checked="" type="checkbox"/> Status de Valise | <input type="checkbox"/> Portes Coulissantes           | <input type="checkbox"/> Hayon arri re     |
| <input checked="" type="checkbox"/> Valise         | <input type="checkbox"/> Status de Capot             | <input type="checkbox"/> D givrage                     | <input type="checkbox"/> Signal de Frein   |

### Connection for Transponder bypass./ Connexion pour le contournement transpondeur.

**ATTENTION:** Les fils d'ignition et d'accessoire du d marreur   distance doivent  tre connect s au barillet d'ignition.

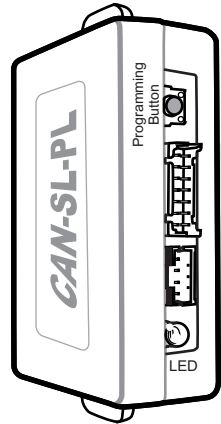
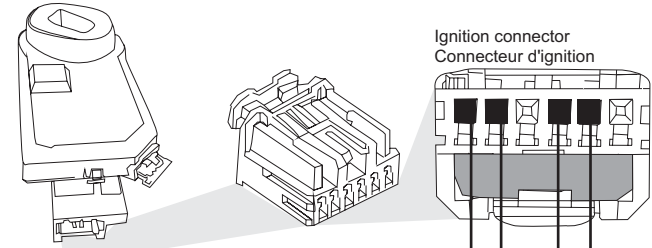

Front of the module

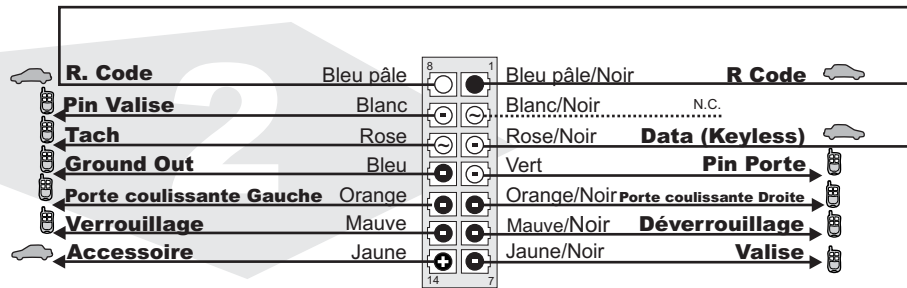
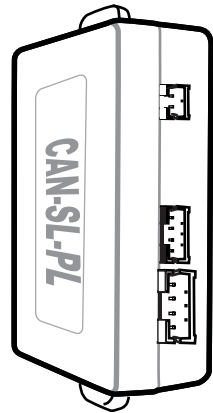

Pour contr le du verrouillage des portes et valise. Pin 12 Beige/Blanc

Situ  du c t  droit de la console centrale.

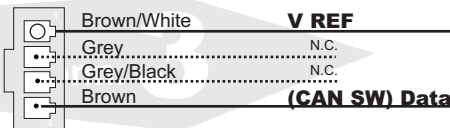
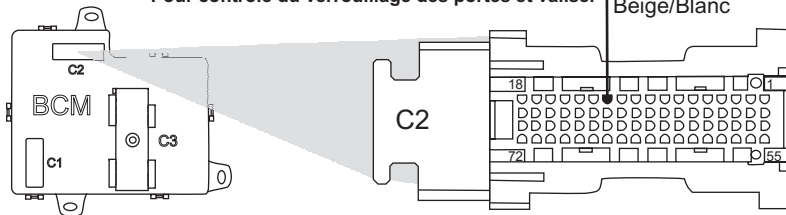

Vert Pin 1

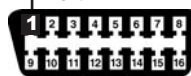

Ignition connector  
Connecteur d'ignition

IGNITION  
Jaune

ACCESSORY  
Brun

V DATA  
Blanc

V REFERENCE  
Blanc/Noir

Branchement du filage au d marreur   distance/Alarme Branchement du filage au v hicule O SORTIE ● ENTR E



Support Technique:  
TEL: 514-255-HELP (4357)  
FAX: 514-255-1367  
Site internet: [www.ifar.ca](http://www.ifar.ca)

Ni le manufacturier, ni le distributeur ne se consid rent responsables des dommages caus s ou ayant pu  tre caus s, indirectement ou directement, par ce module, except  le remplacement de ce module en cas de d fectuosit  de fabrication. Ce module doit  tre install  par un technicien qualifi . Ce guide d'instruction peut faire l'objet de changement sans pr avis. Consultez le [www.ifar.ca](http://www.ifar.ca) pour voir la plus r cente version.

<p><b>Branchez:</b> ✓</p> <table border="0"> <tr><td><input checked="" type="checkbox"/> Bleu p�le</td><td><input checked="" type="checkbox"/> Bleu p�le/Noir</td></tr> <tr><td><input checked="" type="checkbox"/> Blanc</td><td><input checked="" type="checkbox"/> Blanc/Noir</td></tr> <tr><td><input checked="" type="checkbox"/> Rose</td><td><input checked="" type="checkbox"/> Rose/Noir</td></tr> <tr><td><input checked="" type="checkbox"/> Bleu</td><td><input checked="" type="checkbox"/> Vert</td></tr> <tr><td><input checked="" type="checkbox"/> Orange</td><td><input checked="" type="checkbox"/> Orange/Noir</td></tr> <tr><td><input checked="" type="checkbox"/> Mauve</td><td><input checked="" type="checkbox"/> Mauve/Noir</td></tr> <tr><td><input checked="" type="checkbox"/> Jaune</td><td><input checked="" type="checkbox"/> Jaune/Noir</td></tr> </table>	<input checked="" type="checkbox"/> Bleu p�le	<input checked="" type="checkbox"/> Bleu p�le/Noir	<input checked="" type="checkbox"/> Blanc	<input checked="" type="checkbox"/> Blanc/Noir	<input checked="" type="checkbox"/> Rose	<input checked="" type="checkbox"/> Rose/Noir	<input checked="" type="checkbox"/> Bleu	<input checked="" type="checkbox"/> Vert	<input checked="" type="checkbox"/> Orange	<input checked="" type="checkbox"/> Orange/Noir	<input checked="" type="checkbox"/> Mauve	<input checked="" type="checkbox"/> Mauve/Noir	<input checked="" type="checkbox"/> Jaune	<input checked="" type="checkbox"/> Jaune/Noir	<p><b>Data-Link (1 way)</b></p> <p> <input checked="" type="checkbox"/> Brun/Blanc  <input checked="" type="checkbox"/> Gris  <input checked="" type="checkbox"/> Gris/Noir  <input checked="" type="checkbox"/> Brun </p>	<p><b>Branchez:</b> ✓</p> <table border="0"> <tr><td><input checked="" type="checkbox"/> Bleu p�le</td><td><input checked="" type="checkbox"/> Bleu p�le/Noir</td></tr> <tr><td><input checked="" type="checkbox"/> Blanc</td><td><input checked="" type="checkbox"/> Blanc/Noir</td></tr> <tr><td><input checked="" type="checkbox"/> Rose</td><td><input checked="" type="checkbox"/> Rose/Noir</td></tr> <tr><td><input checked="" type="checkbox"/> Bleu</td><td><input checked="" type="checkbox"/> Vert</td></tr> <tr><td><input checked="" type="checkbox"/> Orange</td><td><input checked="" type="checkbox"/> Orange/Noir</td></tr> <tr><td><input checked="" type="checkbox"/> Mauve</td><td><input checked="" type="checkbox"/> Mauve/Noir</td></tr> <tr><td><input checked="" type="checkbox"/> Jaune</td><td><input checked="" type="checkbox"/> Jaune/Noir</td></tr> </table>	<input checked="" type="checkbox"/> Bleu p�le	<input checked="" type="checkbox"/> Bleu p�le/Noir	<input checked="" type="checkbox"/> Blanc	<input checked="" type="checkbox"/> Blanc/Noir	<input checked="" type="checkbox"/> Rose	<input checked="" type="checkbox"/> Rose/Noir	<input checked="" type="checkbox"/> Bleu	<input checked="" type="checkbox"/> Vert	<input checked="" type="checkbox"/> Orange	<input checked="" type="checkbox"/> Orange/Noir	<input checked="" type="checkbox"/> Mauve	<input checked="" type="checkbox"/> Mauve/Noir	<input checked="" type="checkbox"/> Jaune	<input checked="" type="checkbox"/> Jaune/Noir	<p><b>Data-Link (2 way)</b></p> <p> <input checked="" type="checkbox"/> Brun/Blanc  <input checked="" type="checkbox"/> Gris  <input checked="" type="checkbox"/> Gris/Noir  <input checked="" type="checkbox"/> Brun </p>
<input checked="" type="checkbox"/> Bleu p�le	<input checked="" type="checkbox"/> Bleu p�le/Noir																														
<input checked="" type="checkbox"/> Blanc	<input checked="" type="checkbox"/> Blanc/Noir																														
<input checked="" type="checkbox"/> Rose	<input checked="" type="checkbox"/> Rose/Noir																														
<input checked="" type="checkbox"/> Bleu	<input checked="" type="checkbox"/> Vert																														
<input checked="" type="checkbox"/> Orange	<input checked="" type="checkbox"/> Orange/Noir																														
<input checked="" type="checkbox"/> Mauve	<input checked="" type="checkbox"/> Mauve/Noir																														
<input checked="" type="checkbox"/> Jaune	<input checked="" type="checkbox"/> Jaune/Noir																														
<input checked="" type="checkbox"/> Bleu p�le	<input checked="" type="checkbox"/> Bleu p�le/Noir																														
<input checked="" type="checkbox"/> Blanc	<input checked="" type="checkbox"/> Blanc/Noir																														
<input checked="" type="checkbox"/> Rose	<input checked="" type="checkbox"/> Rose/Noir																														
<input checked="" type="checkbox"/> Bleu	<input checked="" type="checkbox"/> Vert																														
<input checked="" type="checkbox"/> Orange	<input checked="" type="checkbox"/> Orange/Noir																														
<input checked="" type="checkbox"/> Mauve	<input checked="" type="checkbox"/> Mauve/Noir																														
<input checked="" type="checkbox"/> Jaune	<input checked="" type="checkbox"/> Jaune/Noir																														



# SATURN Sky

# 2006

MISE À JOUR  
PAR INTERNET

## CAN-SL-PL ET TBGM2

Fabriqué au Canada Rev.B - 01 / 02 / 2009  
Site internet <http://www.ifar.ca>

MODULE D'INTERFACE CAN BUS POUR ALARME ET DÉMARREUR À DISTANCE

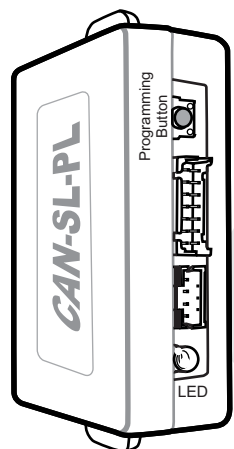

Front of the module

# 1

**Connecteur 1 (Noir - 4 pins):**  
Déterminez le type d'installation:

**INSTALLATION  
AVEC  
DATA-LINK**

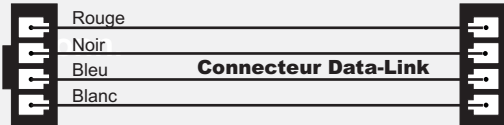

Démarrreur à distance  
et Alarme



**INSTALLATION  
SANS  
DATA-LINK**

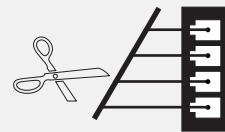
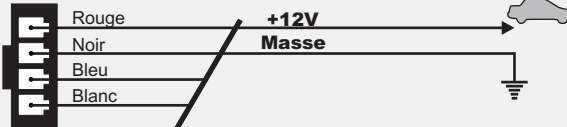

Coupez les 4 fils à l'extrémité de l'un des deux connecteurs Data-Link.  
Connectez le fil rouge au 12V et le fil noir à la masse du véhicule.

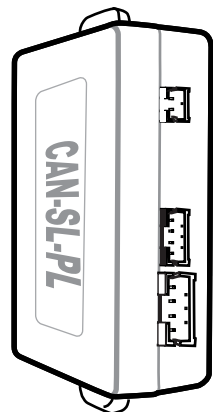

# 5

**Connecteur pour  
mise à jour  
par internet\***

\*Connecteur non fournis

**Connecteur 4 (Blanc - 4  
pins):**  
Connectez avec le *FLASH  
LINK UPDATER* pour les  
mises à jour par internet.

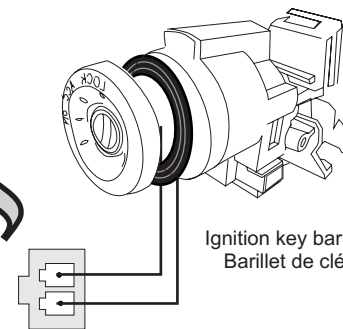

Ignition key barrel  
Barillet de clé

ANTENNA-RING  
ANTENNE-ANNEAU

Branchement du filage au démarreur à distance/Alarme Branchement du filage au véhicule ○ SORTIE ● ENTRÉE



**Support Technique:**  
TEL: 514-255-HELP (4357)  
FAX: 514-255-1367  
Site internet: [www.ifar.ca](http://www.ifar.ca)

Ni le fabricant, ni le distributeur ne se considèrent responsables des dommages causés ou ayant pu être causés, indirectement ou directement, par ce module, excepté le remplacement de ce module en cas de défectuosité de fabrication. Ce module doit être installé par un technicien qualifié. Ce guide d'instruction peut faire l'objet de changement sans préavis. Consultez le [www.ifar.ca](http://www.ifar.ca) pour voir la plus récente version.

## CAN-SL-PL PROGRAMMING

**1** Effectuez les connexions du CAN-SL-PL au véhicule:

**1.A** **Connecteur 1 (Noir):**  
Déterminez le type d'installation (**Data-Link** ou **non Data-Link**)  
Pour l'installation DATA-LINK assurez vous de la présence du connecteur DATA-LINK sur le démarreur.  
Pour installation non Data-Link voir INSTALLATION SANS DATA-LINK.

**1.B** **Connecteur 2 (Blanc):**  
Effectuez les branchements

**1.C** **Connecteur 3 (Blanc, situé au dos du module):**  
Effectuez les branchements

**2** Maintenez le bouton de programmation enfoncé en insérant le connecteur 1 dans le CAN-SL-PL  
Le DEL s'allume pour indiquer le début de la programmation, relâchez le bouton de programmation.

**3** Branchez le connecteur 2 (CONN. 2)  
**ATTENTION: Ne pas brancher le connecteur à l'envers.**

**4** Branchez le connecteur 3 (CONN. 3)

**5** Tournez la clef en position **ignition**.

**6** Lorsque le DEL clignote rapidement, tournez la clef en position **OFF**.  
Le DEL s'éteint pour indiquer que le module est programmé.

## TBGM2 PROGRAMMING

**7** Introduisez la première clé dans le contact et tournez-la à la position **ON** pendant **1 secondes**.

**8** Retirez la clé.

**9** Placez le module TBGM2 prêt du devant du barillet d'ignition.

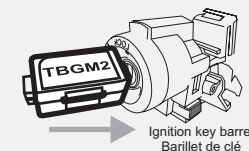

**VOUS AVEZ 5 SECONDES POUR EFFECTUER L'ÉTAPE SUIVANTE:**

**10** Démarrez le véhicule avec le démarreur à distance.  
**Le TBGM2 EST PROGRAMMÉ.**

**IMPORTANT :** Une fois le TBGM2 programmé, il ne peut être reprogrammé sur un autre véhicule.

**11**

- ▶ Retirez le capuchon du plastique du barillet d'ignition.
- ▶ Collez l'antenne (ring) autour du barillet d'ignition.
- ▶ Réinstallez le capuchon du barillet d'ignition.

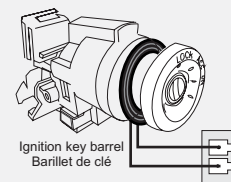

**12** Branchez le module TBGM2 dans le module CAN-SL-PL en utilisant le PATS-LINK.

